

CV16-20

Check Valve, 207 BAR Rated

A screw-in, cartridge-style, hydraulic check valve for use as a blocking or load-holding device.

Porting	Hydraforce code	Article no.	Spring Options	Price £	Price €
Cartridge Version	CV16-20-0-N-*	CV1620C*		£49.10	€59.00
INLINE 3/4" BSP	CV16-20-6B-N-*	CV16206B*	* suffix with 5 = 0.35 BAR (5 PSI) 25 = 1.7 BAR (20 PSI)	£98.40	€118.00
INLINE 1" BSP	CV16-20-8B-N-*	CV16208B*	60 = 4.1 BAR (60 PSI)	£98.40	€118.00

with nitril seals / Viton on request

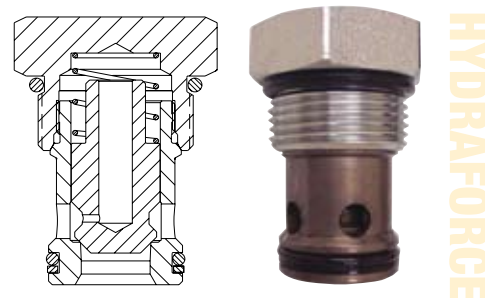

HYDRAFORCE

Materials

Cartridge:

Weight: 0.29 kg. (0.63 lbs.)
Steel with hardened work surfaces.
Zinc-plated exposed surfaces.
Buna N O-rings and polyester elastomer back-ups standard.

Standard Ported Body:

Weight: 0.57 kg. (1.25 lbs.)
Anodized highstrength 6061 T6 aluminum alloy, rated to 207 bar (3000 psi).
Ductile iron bodies available; dimensions may differ.

Dimensions

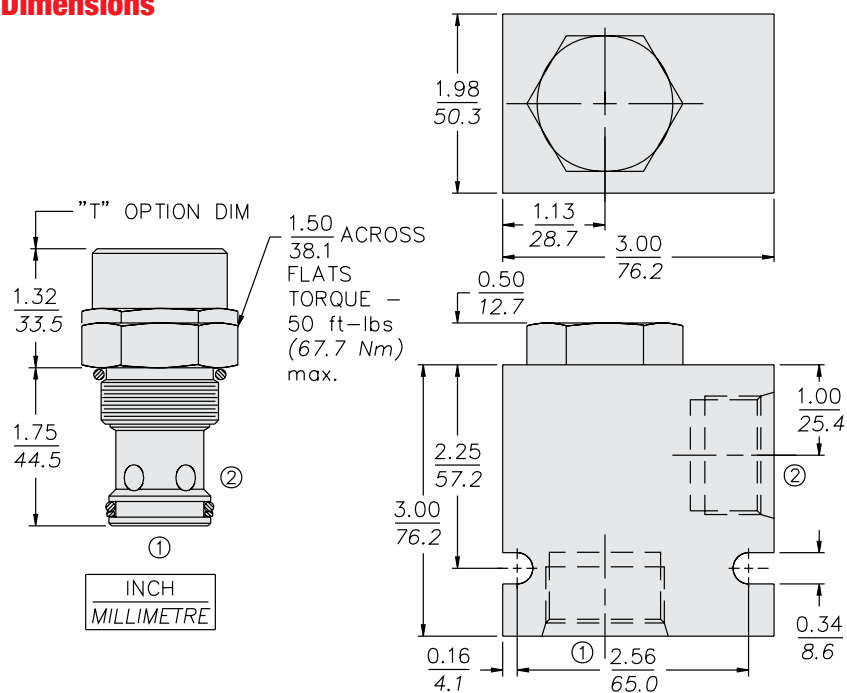

Symbols

USASI:

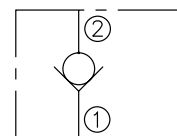

ISO:

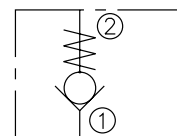

Performance

① to ②: 0.34 bar/5 psi spring — ;
1.72 bar/25 psi spring - - -
32 cSt/150 ssu oil at 40°C

