

DC10-40

Pilot Operated Check Valve, 207 BAR Rated

A dual pilot operated check valve for use in blocking or load-holding circuits. This valve has an optional thermal relief from port ④ to port ③.

Porting	Hydraforce code	Article no.	Price £	Price €
Cartridge Version	DC10-40-0-N25	DC10400C25	£73.70	€88.50
INLINE 1/4"BSP	DC10-40-2B-N25	DC10402B25	£119.90	€144.00
INLINE 3/8"BSP	DC10-40-3B-N25	DC10403B25	£119.90	€144.00

with nitril seals / Viton on request

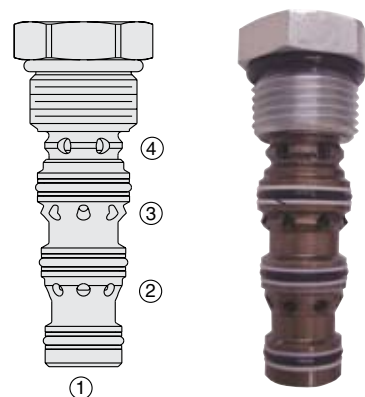

Materials

Cartridge:

Weight: 0.13 kg. (0.28 lbs.)
Steel with hardened work surfaces.
Zinc-plated exposed surfaces.
Buna N O-rings and polyester elastomer back-ups standard.

Standard Ported Body:

Weight: 0.34 kg. (0.75 lbs.)
Anodized highstrength 6061 T6 aluminum alloy, rated to 207 bar (3000 psi).
Ductile iron bodies available; dimensions may differ.

Dimensions

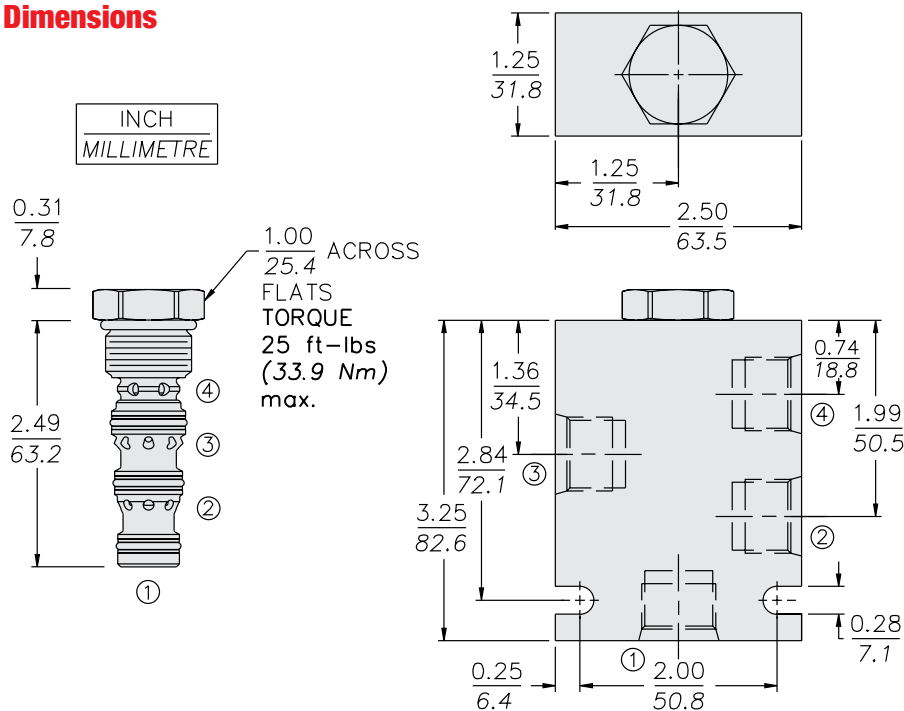

Symbols

USASI:

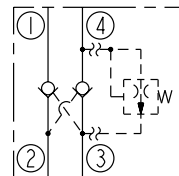

ISO:

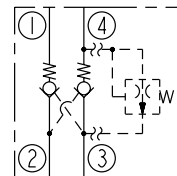

Performance

