

## LS10-30

### Load Shuttle, Ball Type, 207 BAR Rated

A load-shuttling, screw-in, cartridge-style hydraulic check valve, for use in blocking circuits where a priority of flow/direction is given to a higher pressure circuit over a lower one.

Porting	Hydraforce code	Article no.	Price £	Price €
Cartridge Version	LS10-30-0-N25	<b>LS10300C25</b>	<b>£28.70</b>	<b>€34.40</b>
INLINE 1/4" BSP	LS10-30-2B-N25	<b>LS10302B25</b>	<b>£65.90</b>	<b>€79.10</b>
INLINE 3/8" BSP	LS10-30-3B-N25	<b>LS10303B25</b>	<b>£65.90</b>	<b>€79.10</b>

with nitril seals / Viton on request

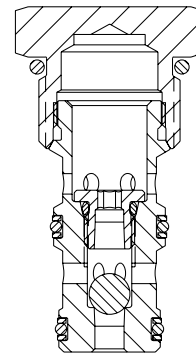

HYDRAFORCE

### Materials

#### Cartridge:

Weight: 0.08 kg. (0.18 lbs.)  
Steel with Zinc-plated exposed surfaces.  
Buna N O-rings and polyester elastomer back-ups standard.

#### Standard Ported Body:

Weight: 0.36 kg. (0.80 lbs.)  
Anodized highstrength 6061 T6 aluminum alloy, rated to 207 bar (3000 psi).  
Ductile iron bodies available; dimensions may differ.

### Dimensions

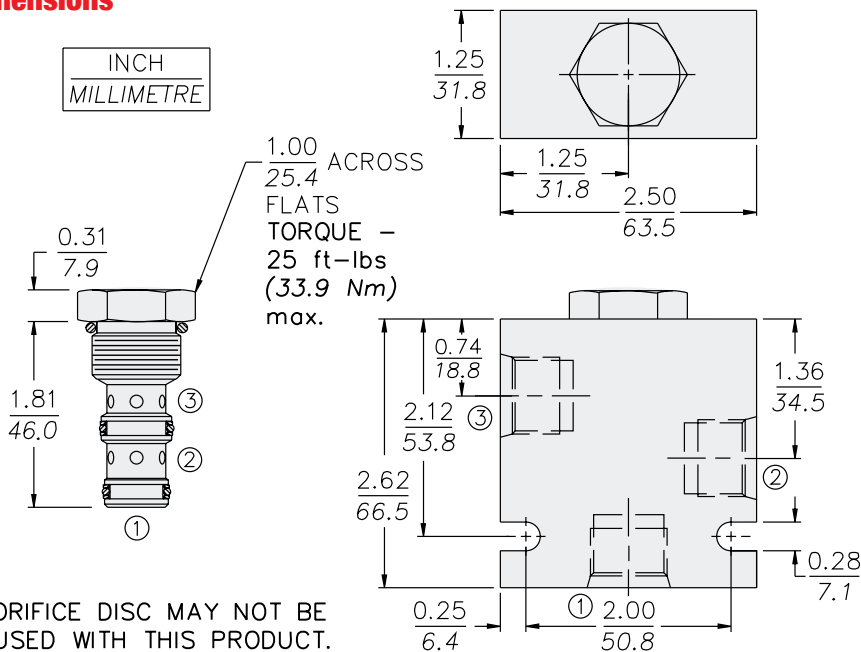

### Symbols

#### USASI/ISO:

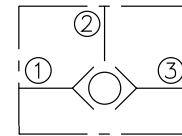

### Performance

