

EC10-30

Pressure Compensator, 207 BAR Rated

A screw-in, cartridge-style pressure-compensating element, intended for use with a remote fixed or variable orifice to yield a two-port-type, pressure-compensated, flow regulating hydraulic valve.

Operation

The EC10-30 maintains a constant flow rate from ② regardless of load pressure changes in the circuit downstream of ②.

The cartridge maintains a constant differential pressure from circuit point P to port ③, thereby regulating the hydraulic flow rate between the two points in the circuit.

Porting	Hydraforce code	Article no.	Spring Options	Price £	Price €
Cartridge Version	EC10-30-0-N*	EC10300C*		£42.10	€50.50
			* suffix with		
INLINE 1/4" BSP	EC10-30-2B-N*	EC10302B*	40 = 2.8 BAR (40 PSI) 80 = 5.52 BAR (80 PSI)	£79.40	€95.20
INLINE 3/8" BSP	EC10-30-3B-N*	EC10303B*	160 = 11 BAR (160 PSI)	£79.40	€95.20

with nitril seals / Viton on request

Dimensions

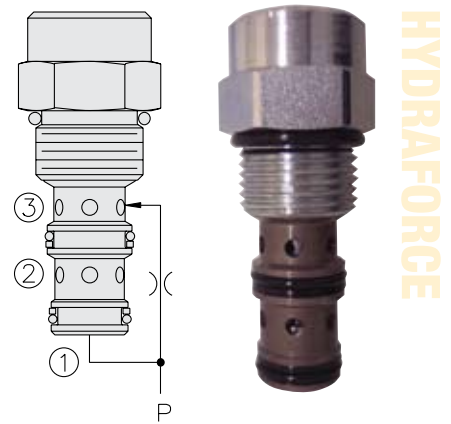
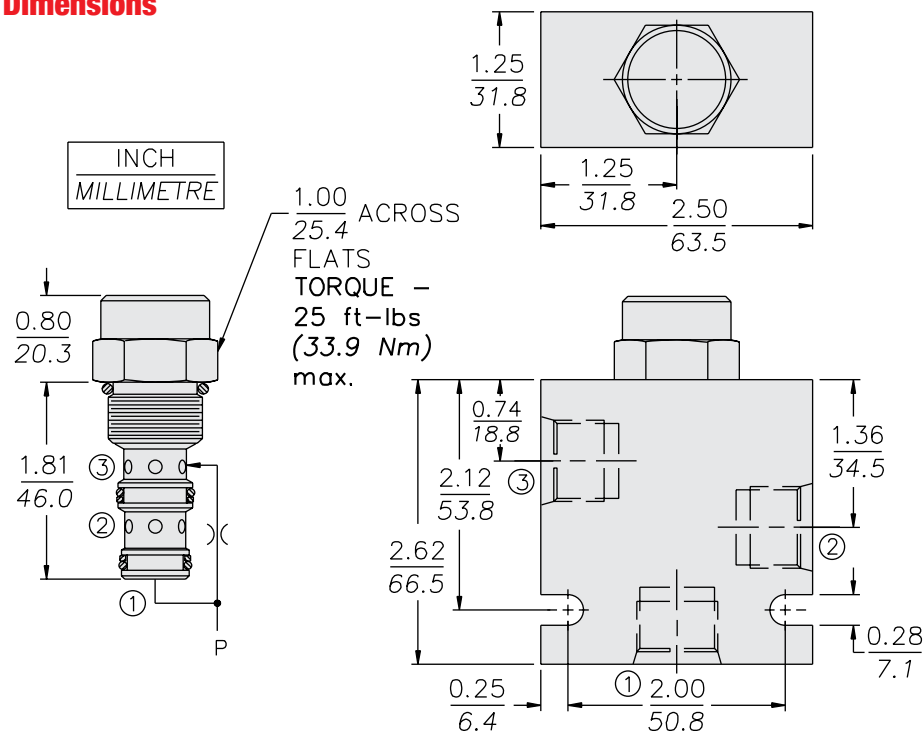

Materials

Cartridge:

Weight: 0.11 kg. (0.25 lbs.)
Steel with hardened work surfaces.
Zinc-plated exposed surfaces.
Buna N O-rings and polyester elastomer back-ups standard.

Standard Ported Body:

Weight: 0.36 kg. (0.80 lbs.)
Anodized highstrength 6061 T6 aluminum alloy, rated to 207 bar (3000 psi).
Ductile iron bodies available; dimensions may differ.

Symbols

USASI:

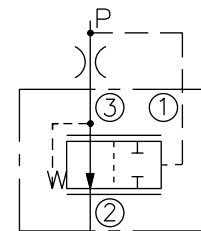

ISO:

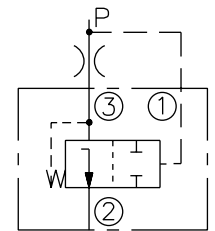

Performance

Output Flow vs. Orifice Dia.
with 80 psid Spring
32 cSt/150 ssu oil at 40°C

