



Series: IV-HP

10,000 PSI Rated

Technical Features and Options

- Interchangeability: With similar couplings
- Valve system: Ball valve
- Mechanical connection: Screw system
- Connection system: Screw to connect
- Disconnection system: Unscrew to disconnect
- Connection with residual pressure: Not allowed
- Disconnection with residual pressure: Not allowed
- Threads available: NPT
- Temperature range:
Standard seals NBR (Nitrile): from -20°C to +100°C (from -4°F to +212°F).

How To Use

- Before connecting, clean the mating parts of the couplings to avoid contamination into the circuit.
- To connect insert the male coupling in the female coupling, move forward the sleeve of the female coupling and screw it manually on the male coupling till it locks.
- To disconnect unscrew totally the sleeve from the male coupling.

Warning!

- Do not couple-uncouple with flow and/or pressure in the circuit.
- Use protection whenever connecting or disconnecting with high temperature (max. allowed 80°C, 176°F).
- When the couplings are disconnected, we recommend the use of protection caps.

Materials

Construction material:	High resistance carbon steel
Surface treatment:	CrIII zinc plated
Springs:	C72 steel
Balls:	Hard steel 100 C6
Seals:	NBR (Nitrile)
Anti-extrusion rings:	PTFE

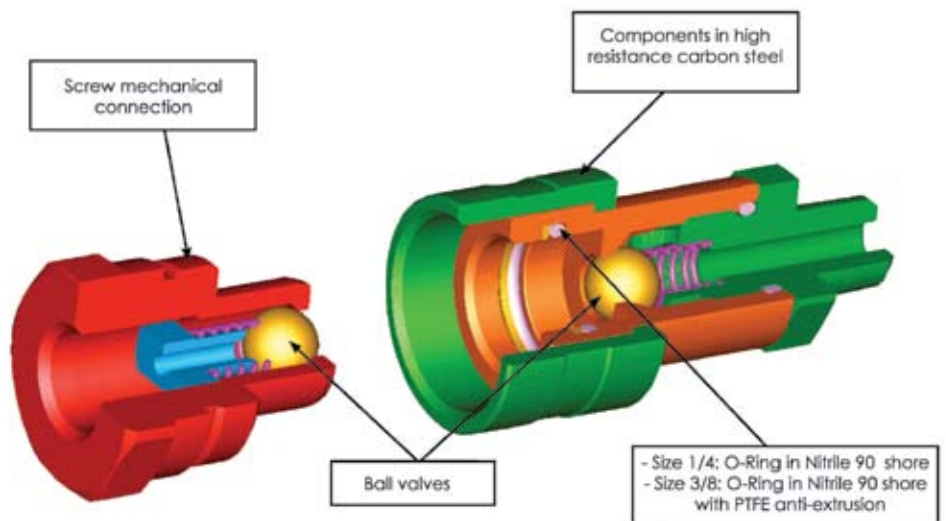

Performance

	Size	ISO Size	Max. flow suggested		Max. operating pressure	
	Inch	mm	l/min	GPM	Mpa	psi
IV14HP	1/4	-	12	3.18	70	10000
IV38HP	3/8	-	23	6.10	70	10000



Stucchi®

Series: IV-HP

10,000 PSI Rated



QUICK CONNECT COUPLINGS



Stucchi®

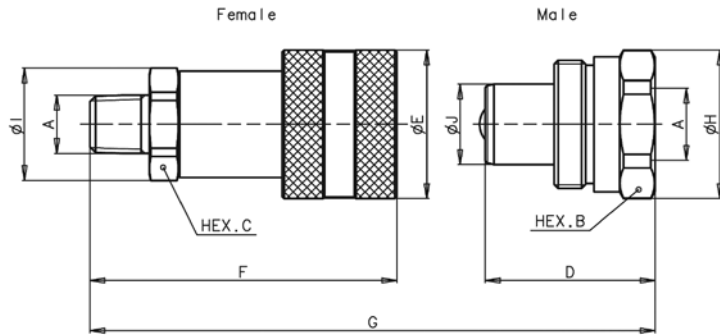

Dimensions (mm)

	A	B	C	D	E	F	G	H	I	J	Weight	Male	Female
IV14HP NPT	1/4	19	22	32.5	28	60.8	74.5	28	24.5	15.8	Kg	0.074	0.138
IV38HP NPT	3/8	32	24	40	35	72.2	86.8	35	26.5	19	Kg	0.140	0.223

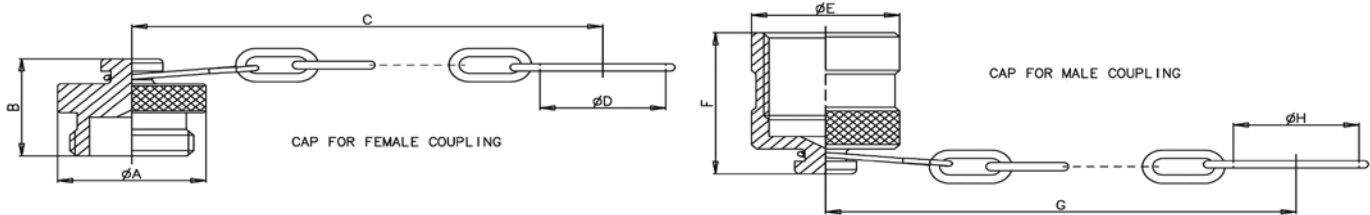

Dimensions For Caps

Coupling	unit	A	B	C	D	E	F	G	H	Weight Kg
F-IV14HP NPT	mm	28	20.5	98	24	-	-	-	-	0.045
M-IV14HP NPT	mm	-	-	-	-	28	28.5	98	24	0.040
F-IV38HP NPT	mm	35	23.5	110	24	-	-	-	-	0.070
M-IV38HP NPT	mm	-	-	-	-	35	36.6	110	24	0.095

Article no.	Description	Price £	Price €
NPT THREAD			
800201008	F. IV14HP NPT EST*	£20.30	€21.30
800201009	M. IV14HP NPT	£11.60	€12.20
800201004	F. IV38HP NPT EST*	£19.30	€20.30
800201005	M. IV38HP NPT	£11.10	€11.60
800201006	F. IV38HP 1/4 NPT EST*	£21.70	€22.80
800200026	F. IV14HP BSP	£20.30	€21.30
800200027	M. IV14HP BSP	£14.20	€14.90
800201014	F. IV38HP NPT	£19.10	€20.10

Article no.	Description	Price £	Price €
ZINC PLATED STEEL CAPS "IV-HP"			
815605004	CAP F. IV14HP	£6.80	€7.10
815605005	CAP M. IV14HP	£6.80	€7.10
815605002	CAP F. IV38HP	£6.80	€7.10
815605003	CAP M. IV38HP	£6.80	€7.10
PLASTIC CAPS "IV-HP"			
815603010	CAP F. IV14HP (BLACK)	£2.00	€2.10
815603011	CAP M. IV14HP (BLACK)	£2.00	€2.10
815603012	CAP F. IV38HP (BLACK)	£2.00	€2.10
815603013	CAP M. IV38HP (BLACK)	£2.00	€2.10

* with male thread connection as shown on diagram above, otherwise the connection has female thread