

High Pressure Multiway Ball Valve 3 Way – 3KH Series

500-250 BAR Rated

Threaded Female BSP Parallel

Dimensions

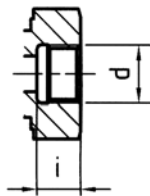
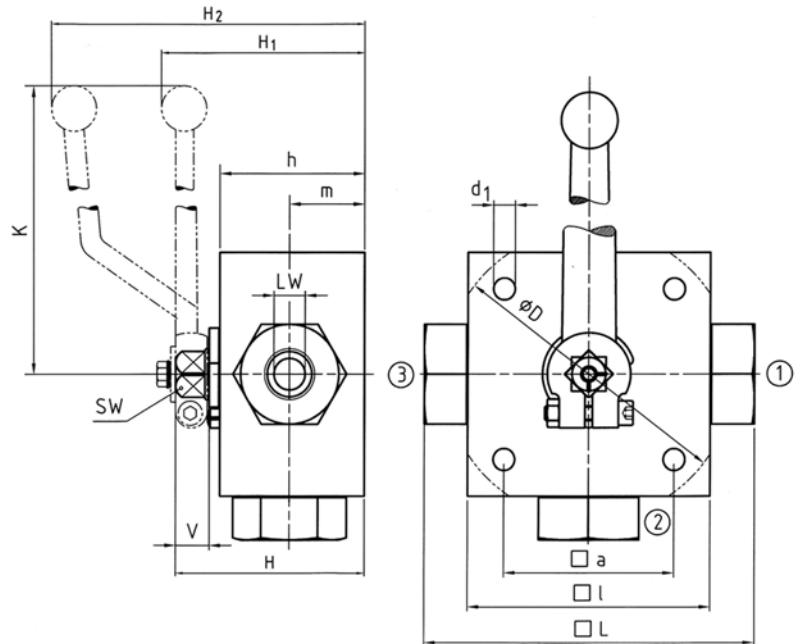

BSP
DIN ISO 228

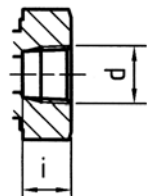

NPT
ANSI B1.20.1

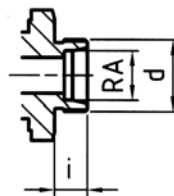

DIN 2353 L

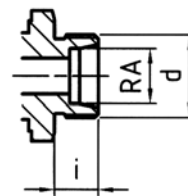

DIN 2353 S

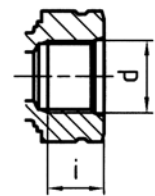

SAE J 514

DIN ISO 228 Female thread

Type	DN	LW	L	D	I	a	H	h	m	K	V	SW	i	d	d ₁	H ₁	H ₂	Weight
3KH-G1/8	4	5	100	-	70	55	58	40	22	160	14	12	10	G1/8	6.5	-	101	1.60
3KH-G1/4	6	5	100	-	70	55	58	40	22	160	14	12	14	G1/4	6.5	-	101	1.60
3KH-G3/8	10	8	115	-	80	65	68	50	27	200	14	14	14	G3/8	6.5	72	-	2.70
3KH-G1/2	13	13	136	-	100	80	78	60	31	200	14	14	16,3	G1/2	9	82	-	4.90
3KH-G5/8	16	13	139	-	100	80	78	60	31	200	14	14	18	G5/8	9	82	-	4.90
3KH-G3/4	20	18	154	138	113	85	88	67	36.5	320	16.5	17	18	G3/4	8.5	96	-	6.70
3KH-G1	25	23	172	138	119	85	103	82	47.5	320	16.5	17	20	G1	8.5	112	-	8.30
3KH-G1 1/4	25/32	23	180	138	119	85	103	82	47.5	320	16.5	17	22	G1 1/4	8.5	112	-	8.50
3KH-G1 1/2	25/40	23	180	138	119	85	103	82	47.5	320	16.5	17	24	G1 1/2	8.5	112	-	8.50

These products are not 'PED Compliant' for use with GAS

Should you have a GAS application please contact our sales office in order that they can check the PED requirements and offer a CE marked suitable product.

High Pressure Multiway Ball Valve 3 Way – 3KH Series

500-250 BAR Rated

Threaded Female BSP Parallel



HIGH PRESSURE BALL VALVES

Size	Max pressure BAR	Article no. 'L' Bore	Price £	Price €	Article no. 'T' Bore	Price £	Price €
1/4"	500	9105002	£170.90	€179.50	9105012	£179.20	€188.20
3/8"	500	9105003	£199.80	€209.80	9105013	£205.20	€215.40
1/2"	400	9105004	£252.30	€265.00	9105014	£260.00	€273.00
3/4"	315	9105005	£425.10	€446.40	9105015	£446.30	€468.60
1"	315	105006	£532.00	€558.60	105016	£538.80	€565.70
1 1/4"	315	105007	£644.40	€676.60	105017	£644.40	€676.60
1 1/2"	250	105008	£664.90	€698.10	105018	£664.90	€698.10

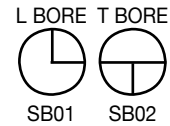

Materials

Body	Steel 9SMn28K
Ball	Chromed Steel
Stem Seal	NITRIL (Others On Request)
Ball Seal	POM-MoS2
Temp. Range	-20 TO +100°C

3/2-WAY BALL VALVE, OPERATION 45° WITH OPEN CROSS-OVER

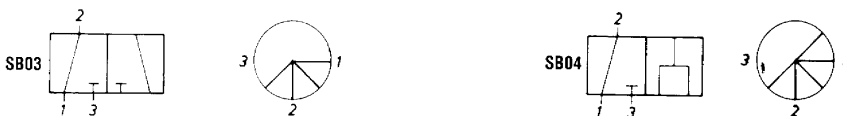

3/3-WAY BALL VALVE, OPERATION 90° WITH CLOSED POSITION AT 45°

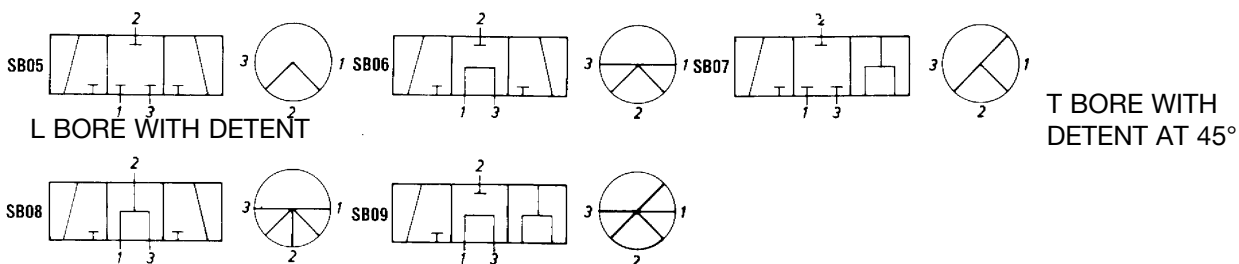

3/3-WAY BALL VALVE, OPERATION 180° WITH CLOSED POSITION AT 45° & 135°

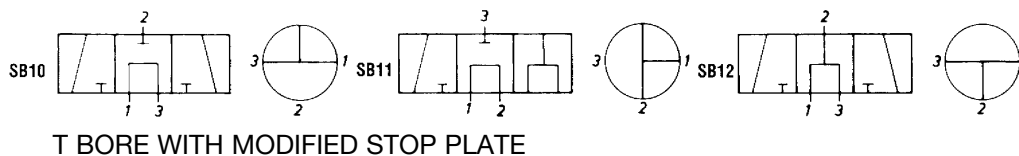

These products are not 'PED Compliant' for use with GAS

Should you have a GAS application please contact our sales office in order that they can check the PED requirements and offer a CE marked suitable product.