



Stainless Steel High Pressure 2 Way Ball Valves MKH Series

420 BAR Rated

Threaded Female BSP Parallel/NPT

Size BSP	Max Pressure BAR	Article no. BSP	Price £	Price €	Article no. NPT	Price £	Price €
1 1/4"	420	9902007	£501.30	€516.90	9902017	£804.20	€829.40
1 1/2"	420	9902008	£696.80	€718.60	9902018	£876.90	€904.30
2"	420	9902009	£928.50	€957.50	9902019	£928.50	€957.50

Materials

Body	316 Stainless Steel
Ball	316 Stainless Steel
Stem Seal	NITRIL (Others On Request)
Ball Seal	POM-MoS2 (Others On Request)
Temp. Range	-10 TO +100°C

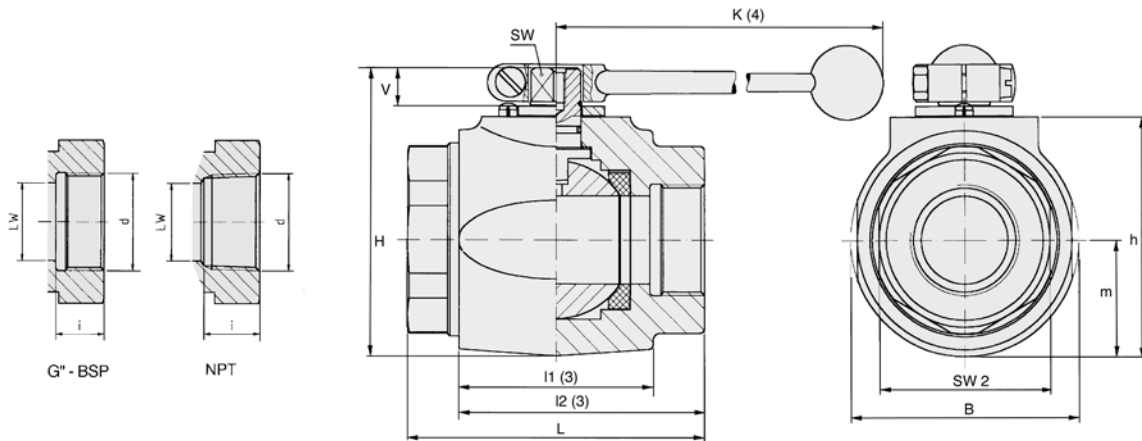

NOTE: SUPPLIED WITH CRANKED HANDLES

Dimensions (mm)

SIZE	DN	LW	L	I	B	H	h±0.5	m	V	SW	K	i	SW	d	kg
Female Thread DIN/ISO 228 - bsp / ANSI B1.20.1 - NPT															
1 1/4"	32	32	111	95	81	107	86	40,5	16,5	17	320	22	60	1 1/4"	3,2
1 1/2"	40	38	130	107,5	100	124	103	50	16,5	17	320	24	75	1 1/2"	4,3
2"	50	48	140	120	118	138	117	59	16,5	17	320	26	85	2"	10