

High Pressure 2-Way Ball Valves Carbon Steel BKH Series – Compression End

Compression Connection – Light Series

Article no. L series	Size DIN2353-L	Max Pressure BAR	Price £	Price €
BKH6L	6L	500	£23.40	€24.20
BKH8L	8L	500	£19.30	€19.90
BKH10L	10L	500	£20.00	€20.60
BKH12L	12L	500	£20.30	€21.00
10115L	15L	500	£22.80	€23.50
BKH18L	18L	420	£23.60	€24.40
BKH22L	22L	420	£44.40	€45.70
BKH28L	28L	315	£71.10	€73.30
BKH35L	35L	315	£74.50	€76.80
BKH42L	42L	315	£120.20	€124.00

* MAXIMUM PRESSURE IS GOVERNED BY THE FITTING DIN2353.
PLEASE CHECK RATING OF FITTING.



ON REQUEST -
WITH WING LEVER

HIGH PRESSURE BALL VALVES

Materials

Body	Steel 11SMn28K - Yellow Zinc Passivated
Ball	Brass - Mirror Finish Chromed
Stem Seal	NITRIL (Others On Request)
Ball Seal	POM-MoS2 (Others On Request)
Temp. Range	-20 to +100°C

Dimensions

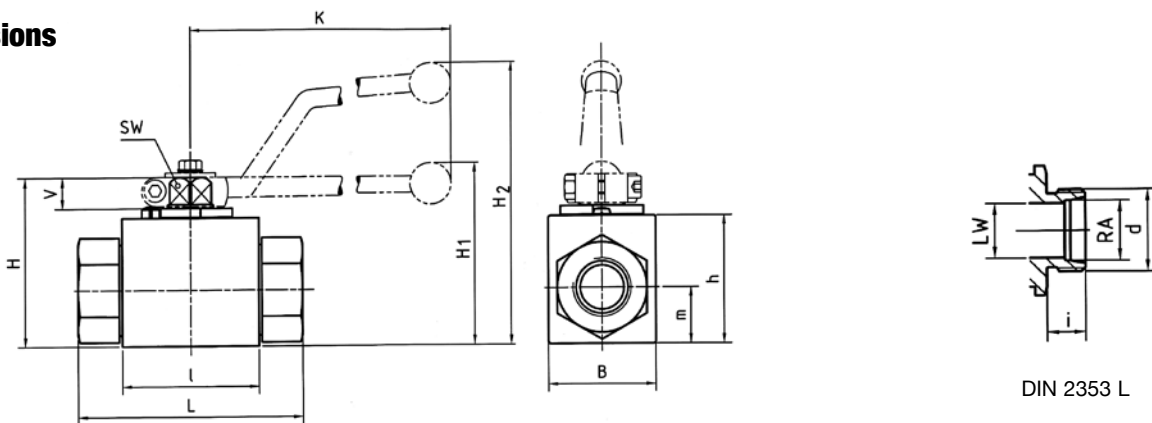

DIN 2353 L

Type	DN	RA	LW	L	I	B	H	h	m	V	SW	K	i	d	H1	H2	Weight
BKH- 6L	4	6	5	67	40	26	47	33	13,5	11	9	115	10	M 12x1,5	-	82	0.36
BKH- 8L	6	8	6	67	40	26	47	33	13,5	11	9	115	10	M 14x1,5	-	82	0.37
BKH-10L	8	10	8	74	40	26	47	33	13,5	11	9	115	11	M 16x1,5	-	82	0.38
BKH-12L	10	12	10	74	43	32	52	38	17,5	11	9	115	11	M 18x1,5	-	86	0.50
BKH-15L	13	15	13	82	48	35	54	40	19	11	9	115	12	M 22x1,5	-	89	0.61
BKH-15L	16	15	15	82	48	38	63	46	19	13	12	160	12	M 22x1,5	-	106	0.70
BKH-18L	13	18	13	82	48	35	54	40	19	11	9	115	12	M 26x1,5	-	89	0.60
BKH-18L	16	18	15	82	48	38	63	46	19	13	12	160	12	M 26x1,5	-	106	0.75
BKH-22L	20	22	20	101	62	49	75	57	24,5	14	14	200	14	M 30x2	79	-	1.49
BKH-28L	25	28	25	108	66	58	83	65	29,5	14	14	200	14	M 36x2	87	-	2.00
BKH-35L	25/32	35	25	112	66	58	83	65	29,5	14	14	200	16	M 45x2	87	-	2.12
BKH-42L	25/40	42	25	112	66	58	83	65	29,5	14	14	200	16	M 52x2	87	-	2.27

These products are not 'PED Compliant' for use with GAS

Should you have a GAS application please contact our sales office in order that they can check the PED requirements and offer a CE marked suitable product.