

800 BAR Ball Valve - BKHP800 Series Full Bore

Carbon Steel
800 BAR Rated



HIGH PRESSURE BALL VALVES



Article no.	Size NPT	Price £	Price €
80001	1/4"	£168.40	€173.70
80002	3/8"	£168.40	€173.70
80003	1/2"	£168.40	€173.70
80004	3/4"	£420.10	€433.30
80005	1"	£420.10	€433.30
457187	1 1/4"	£719.50	€742.00

Materials

Body	Steel
Ball	Steel
Stem	Steel
Ball seats	POM
O-rings	NBR
Tmax	-20°C / 100°C

Dimensions

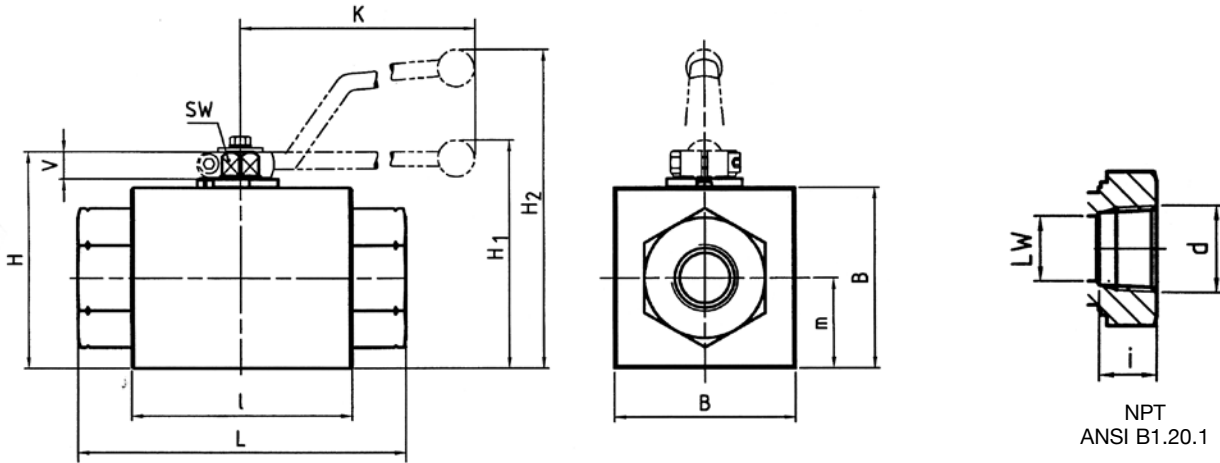

ANSI B 1.20.1 NPT Female thread

Type	DN	LW	L	I	B	H	m	V	SW	K	i	d	H ₁	H ₂	LEVER	Weight kg
BKHP800-1/4" NPT	6	6	130	76	50	64	25	11	9	115	17	1/4" NPT	-	99	Zn	1.30
BKHP800-3/8" NPT	10	13	130	76	50	64	25	11	9	115	17,4	3/8" NPT	-	99	Zn	1.30
BKHP800-1/2" NPT	13	13	130	76	50	64	25	11	9	115	25	1/2" NPT	-	99	Zn	1.30
BKHP800-3/4" NPT	20	20	161	111	90	108	45	14	14	200	23,1	3/4" NPT	112	-	Zn	5.60
BKHP800-1" NPT	25	25	164	111	90	108	45	14	14	200	27,8	1" NPT	112	-	Zn	5.60



ALSO AVAILABLE IN 316 STAINLESS STEEL

These products are not 'PED Compliant' for use with GAS
Should you have a GAS application please contact our sales office in order that they can check the PED requirements and offer a CE marked suitable product.