

Flow Control Needle Valves – Double Acting

210 BAR Rated

Nickel plated brass



Article no.	Size BSP	Max Pressure BAR	Max Flow LPM	Price £	Price €
201020	1/8"	210	2*	£57.20	€59.00
201010	1/8"	210	10	£36.10	€37.30
201011	1/4"	210	20	£33.30	€34.30
201012	3/8"	210	30	£42.20	€43.50
201013	1/2"	210	50	£62.10	€64.10
201014	3/4"	210	90	£115.60	€119.20

* Fine control between 0 & 2 lpm body passivated

316 Stainless Steel with viton seals - 300 BAR RATED



Article no.	Size BSP	Max Pressure BAR	Max Flow LPM	Price £	Price €
201060	1/8"	300	10	£140.10	€144.50
201061	1/4"	300	20	£130.40	€134.40
201062	3/8"	300	30	£161.00	€166.00
201063	1/2"	300	60	£251.20	€259.00
201069	3/4"	300	90	£338.40	€349.00

Panel Mounting Nuts – BRASS



Article no.	Size BSP	Price £	Price €
207010	1/8"	£2.60	€2.70
207011	1/4"	£2.40	€2.50
207012	3/8"	£2.70	€2.80
207013	1/2"	£3.70	€3.80
207006	3/4"	£5.70	€5.90



'MP' PLASTIC HANDLE
on request interchangeable
with aluminium knob

Materials

Body Brass - Nickel Plated Or Stainless Steel
 Stem 304 Stainless Steel
 Stem Seal NITRIL (others on request)
 Temp. Range -20 TO +100°C

Dimensions (mm)

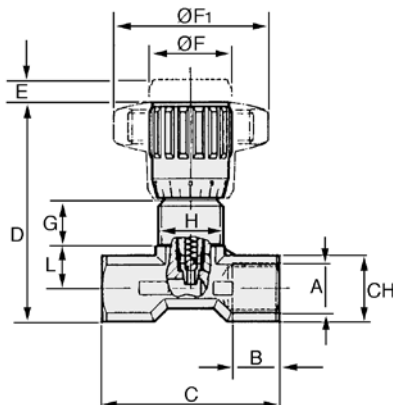

size	B	C	D	E	F	f1	G	H	L	CH	WEIGHT kg
1/8"	8	40	55	4	22	40	12	m15x1	9.5	15	0.105
1/4"	12	46	57	4.5	22	40	12	m17x1	11	17	0.122
3/8"	13	55	69	7	27	50	11.5	M20x1	15	22	0.233
1/2"	16	70	82	10	33	70	13	M25x1.5	19	27	0.455
3/4"	20	91	100	12	38	80	15	M30x1.5	22	34	0.86