

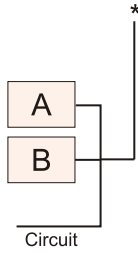

DDF3 – 3 Way Flow Diverters

300 – 350 BAR Rated

Article no.	Size BSP	Max Pressure BAR	Max Flow l/min	Price £	Price €
DDF3140*	1/4"	350	60	£38.00	€39.10
DDF3380*	3/8"	350	60	£38.00	€39.10
DDF3120*	1/2"	350	90	£50.20	€51.70
DDF3340*	3/4"	350	120	£55.10	€56.80
DDF3100*	1"	300	200	£79.50	€81.90

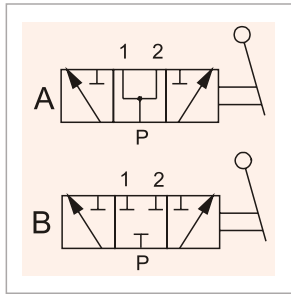

Pressure Drop Graph

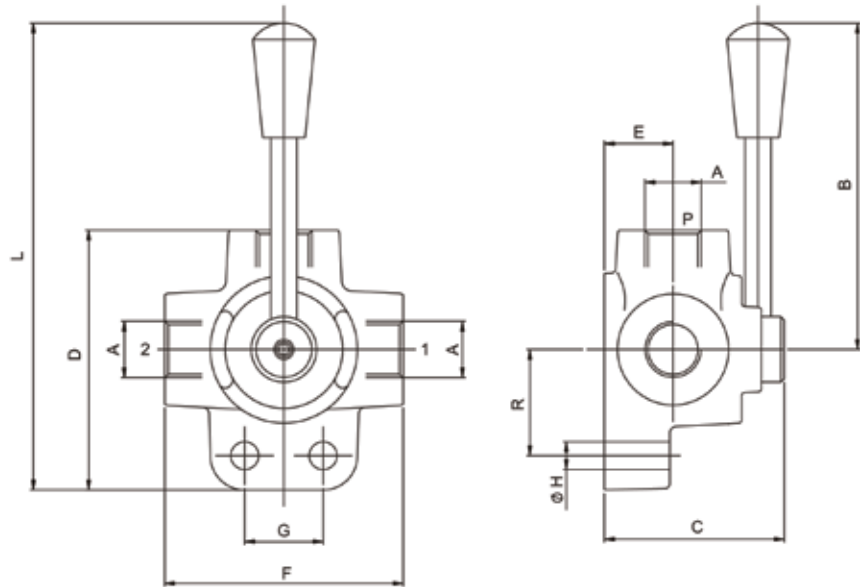
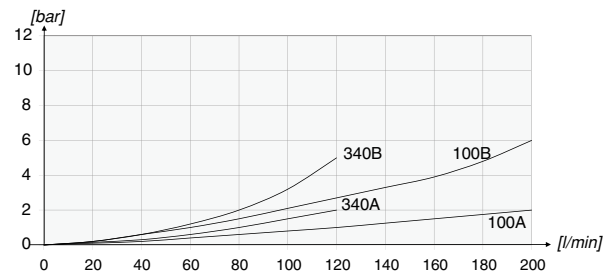
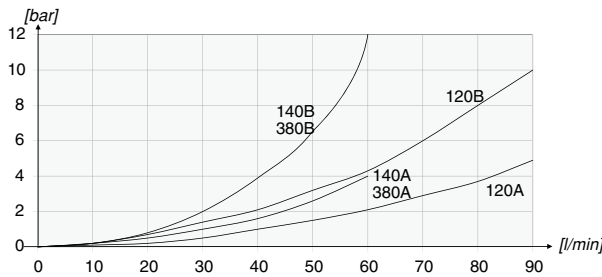

Dimensions (mm)

Code	A	B	C	D	E	F	G	H	L	R	Weight kg
DDF3140	BSPP 1/4	115	57	75.5	21	70	25	8.5	155.5	32	0.80
DDF3380	BSPP 3/8	115	57	75.5	21	70	25	8.5	155.5	32	0.80
DDF3120	BSPP 1/2	115	63	86	24	80	32	8.5	161	36	1.30
DDF3340	BSPP 3/4	115	67	98.5	26	90	32	10.5	168.5	42	1.70
DDF3100	BSPP 1	115	77	110	31	98	32	10.5	176.5	50	2.50