

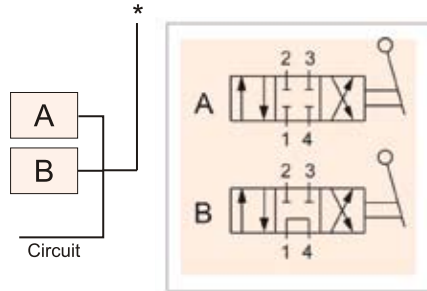

## IDF4 – 4 Way Flow Diverters

300 – 350 BAR Rated

Article no.	Size BSP	Max Pressure BAR	Max Flow l/min	Price £	Price €
<b>IDF4140*</b>	1/4"	350	40	<b>£60.60</b>	<b>€62.40</b>
<b>IDF4380*</b>	3/8"	350	60	<b>£60.60</b>	<b>€62.40</b>
<b>IDF4120*</b>	1/2"	350	90	<b>£63.70</b>	<b>€65.60</b>
<b>IDF4340*</b>	3/4"	350	120	<b>£68.30</b>	<b>€70.30</b>
<b>IDF4100*</b>	1"	300	200	<b>£95.00</b>	<b>€97.90</b>



### Pressure Drop Graph

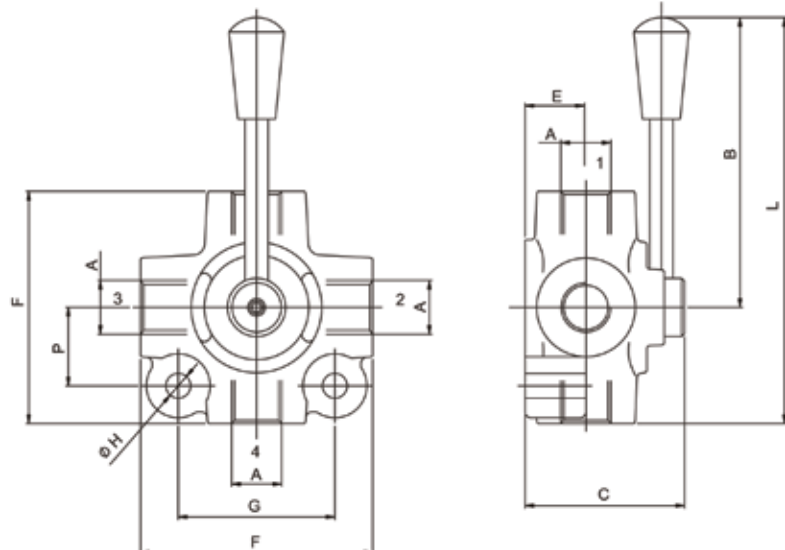
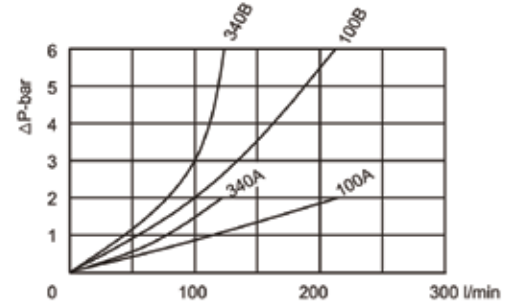
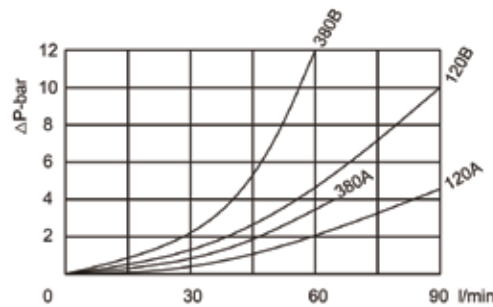

### Dimensions (mm)

Code	A	B	C	E	F	G	H	L	P	Weight kg
IDF4140	BSPP 1/4	115	63	24	80	54	8.5	155	28	1.20
IDF4380	BSPP 3/8	115	63	24	80	54	8.5	155	28	1.20
IDF4120	BSPP 1/2	115	63	24	80	54	8.5	155	28	1.10
IDF4340	BSPP 3/4	115	77	31	94	74	10.5	162	38	2.20
IDF4100	BSPP 1	115	77	31	94	74	10.5	162	38	2.00