

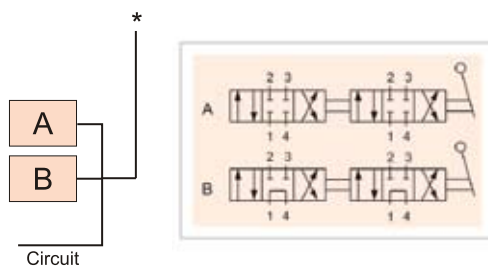

IDF8 – 8 Way Flow Diverters

300 – 350 BAR Rated

Article no.	Size BSP	Max Pressure BAR	Max Flow l/min	Price £	Price €
IDF8140*	1/4"	350	40	£126.30	€130.20
IDF8380*	3/8"	350	60+60	£132.00	€136.00
IDF8120*	1/2"	350	90+90	£138.60	€142.80
IDF8340*	3/4"	350	120+120	£172.80	€178.00
IDF8100*	1"	300	200+200	£194.60	€200.50



Pressure Drop Graph

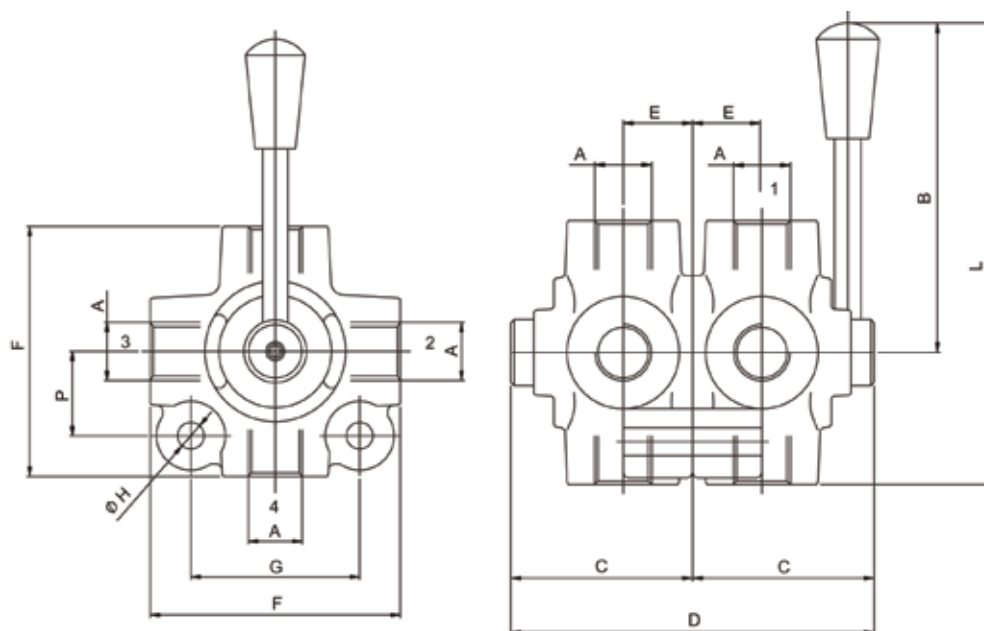
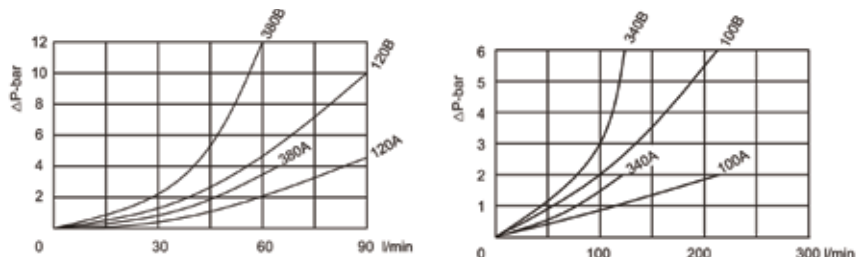

Dimensions (mm)

Code	A	B	C	D	E	F	G	H	L	P	Weight kg
IDF8140	BSPP 1/4										
IDF8380	BSPP 3/8	115	63	124	24	80	54	8.5	155	28	2.30
IDF8120	BSPP 1/2	115	63	124	24	80	54	8.5	155	28	2.10
IDF8340	BSPP 3/4	115	77	152	31	94	74	10.5	162	38	4.30
IDF8100	BSPP 1	115	77	152	31	94	74	10.5	162	38	4.00