

Test Point with "DIN 2353" Compression Connection

Light Series / Heavy Series

Test Point Connection M16x2

160 - 630 BAR Rated



TEST POINTS

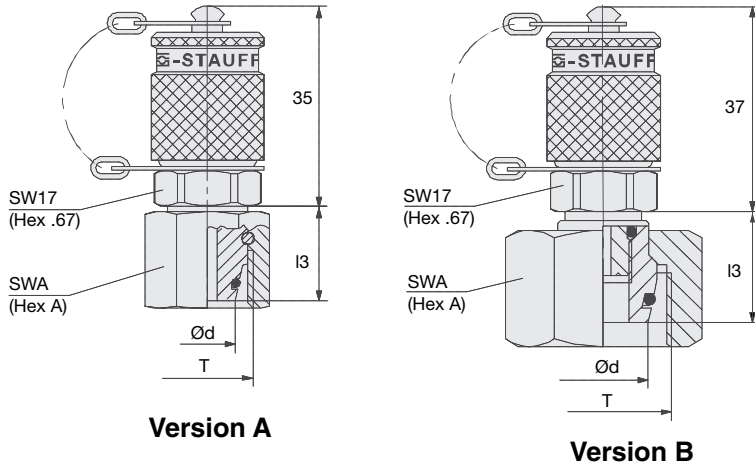

Materials

Body Steel
 316 Stainless Steel - On Request
 Seal NITRIL - Others On Request
 Temp. Range -30 to +100°C

Light Series

TUBE O.D.	T	l3	SW A	Version	PN BAR	Article no.	Price £	Price €
6	M12 x 1.5	15.5	14	A	315	20.51.06	£20.90	€25.10
8	M14 x 1.5	15.5	17	A	315	20.51.08	£15.70	€18.80
10	M16 x 1.5	16.5	19	A	315	20.51.10	£15.80	€18.90
12	M18 x 1.5	17.5	22	A	315	20.51.12	£16.60	€19.90
15	M22 x 1.5	21	27	B	315	20.51.15	£21.90	€26.30
18	M26 x 1.5	19.5	32	B	315	20.51.18	£24.80	€29.70
22	M30 x 2	20.5	36	B	160	20.51.22	£28.90	€34.70
28	M36 x 2	25	41	B	160	20.51.28	£37.40	€44.80
35	M45 x 2	30	50	B	160	20.51.35	£36.30	€43.60
42	M52 x 2	31	60	B	160	20.51.42	£37.30	€44.70

Heavy Series

TUBE O.D.	T	l3	SW A	Version	PN BAR	Article no.	Price £	Price €
6	M14 x 1.5	14.5	17	A	630	20.52.06	£20.90	€25.10
8	M16 x 1.5	16.5	19	A	630	20.52.08	£16.90	€20.20
10	M18 x 1.5	16.5	22	A	630	20.52.10	£23.20	€27.90
12	M20 x 1.5	17.5	24	A	630	20.52.12	£18.20	€21.80
14	M22 x 1.5	19.5	27	B	630	20.52.14	£22.90	€27.50
16	M24 x 1.5	18	30	B	400	20.52.16	£26.10	€31.30
20	M30 x 2	24	36	B	400	20.52.20	£32.40	€38.90
25	M36 x 2	26	46	B	400	20.52.25	£34.70	€41.70
30	M42 x 2	30	50	B	400	20.52.30	£36.90	€44.30
38	M52 x 2	34	60	B	315	20.52.38	£38.50	€46.30