

CV08-20

Check Valve, 207 BAR Rated

A screw-in, cartridge-style, hydraulic check valve for use as a blocking or load-holding device.

Porting	Hydraforce code	Article no.	Spring Options	Price £	Price €
Cartridge Version	CV08-20-0-N-*	CV0820C*	* suffix with 4 = 0.3 BAR (4 PSI) 10 = 0.7 BAR (10 PSI) 25 = 1.7 BAR (20 PSI)	£19.00	€22.80
INLINE 1/4" BSP	CV08-20-2B-N-*	CV08202B*	60 = 4.1 BAR (60 PSI) 100 = 6.9 BAR (100 PSI) 150 = 10.3 BAR (150 PSI)	£55.30	€66.40
INLINE 3/8" BSP	CV08-20-3B-N-*	CV08203B*	200 = 13.8 BAR (200 PSI) 270 = 18.3 BAR (270 PSI)	£55.30	€66.40

with nitril seals / Viton on request

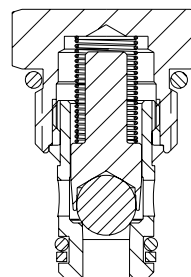

HYDRAFORCE

Materials

Cartridge:

Weight: 0.08 kg. (0.17 lbs.)
Steel with hardened work surfaces.
Zinc-plated exposed surfaces.
Buna N O-rings and back-up standard.

Standard Ported Body:

Weight: 0.16 kg. (0.35 lbs.)
Anodized highstrength 6061 T6 aluminum alloy, rated to 207 bar (3000 psi).
Ductile iron bodies available; dimensions may differ.

Dimensions

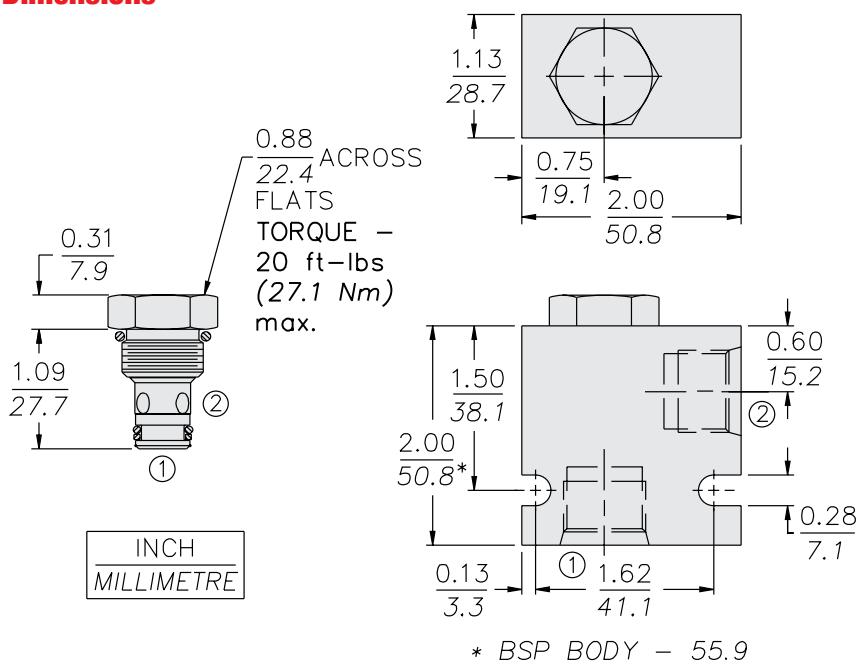

Symbols

USASI:

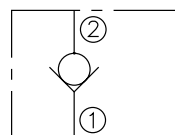

ISO:

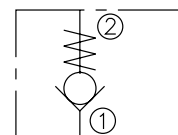

Performance

