

FD52-45

Flow Divider/cominer, Heavy Duty, Multifunction, 5,000 PSI Rated

A heavy duty, multifunction, screw-in, cartridge-style, spool-type flow divider/combiner.

Porting	Hydraforce code	Article no.	Dividing/Combining Ratio	Price £	Price €
Cartridge Version	FD52-45-0-P-*	FD52450C*	* suffix with 44 = 50:50 rated / 60 lpm input	£143.80	€172.50
INLINE SAE 12	FD52-45-6BD-P*	FD524512T*	66 = 50:50 rated / 90 lpm input	£336.80	€404.20

with polyurethane seals

Materials

Cartridge:

Weight: 0.28 kg. (0.61 lbs.)
Steel with hardened work surfaces;
Zinc-plated exposed surfaces.
Buna N O-rings and polyester elastomer back-ups standard.

Special Ported Body:

Ductile iron body required for operation over 207 bar (3000 psi). Aluminum bodies are available for lower pressure operation.

Dimensions

INCH
MILLIMETRE

INSTALLATION TORQUE:
73–77 ft-lbs (99–104 Nm)

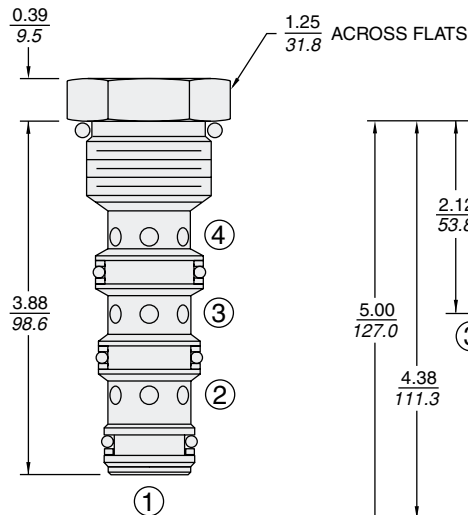

PORT ① IS NOT USED

Body Dimensions shown are for either Ductile Iron or Aluminum

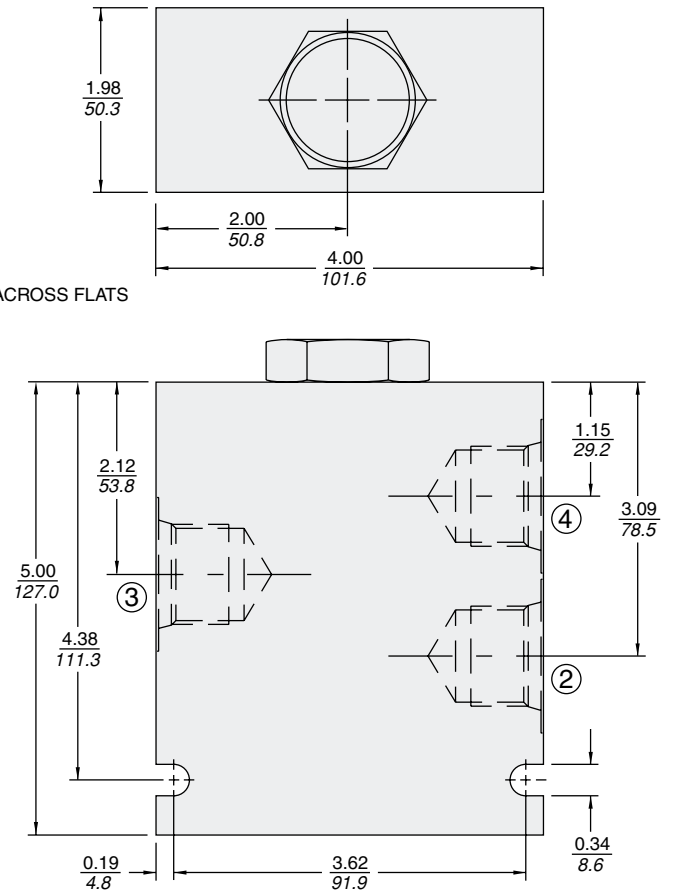

Symbols

USASI:

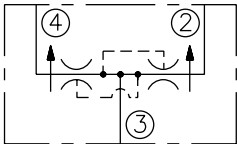

ISO:

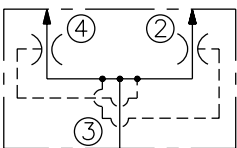

Performance

Pressure Drop vs. Inlet Flow
③ to ② and ④
32 cSt/150 ssu oil at 40°C

