

NV08-20

Needle Valve, 207 BAR Rated

A screw-in, cartridge-style, variable orifice, hydraulic flow restrictor valve.

Porting	Hydraforce code	Article no.	Price £	Price €
Cartridge Version	NV08-20A-0-N	NV0820AC	£41.20	€49.40
INLINE 1/4" BSP	NV08-20A-2B-N	NV0820A2B	£77.60	€93.10
INLINE 3/8" BSP	NV08-20A-3B-N	NV0820A3B	£77.60	€93.10

with nitril seals / Viton on request

- Standard** - with 1/4" HEX ALLEN HEAD (A)
On request - 1 1/2" dia alum knob
 Option (A) with cover cap (C)
 Top knob with locknut
 Top knob only
 Lockwire holes (with option (C))

Dimensions

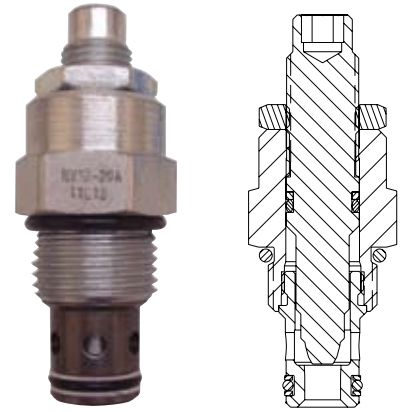
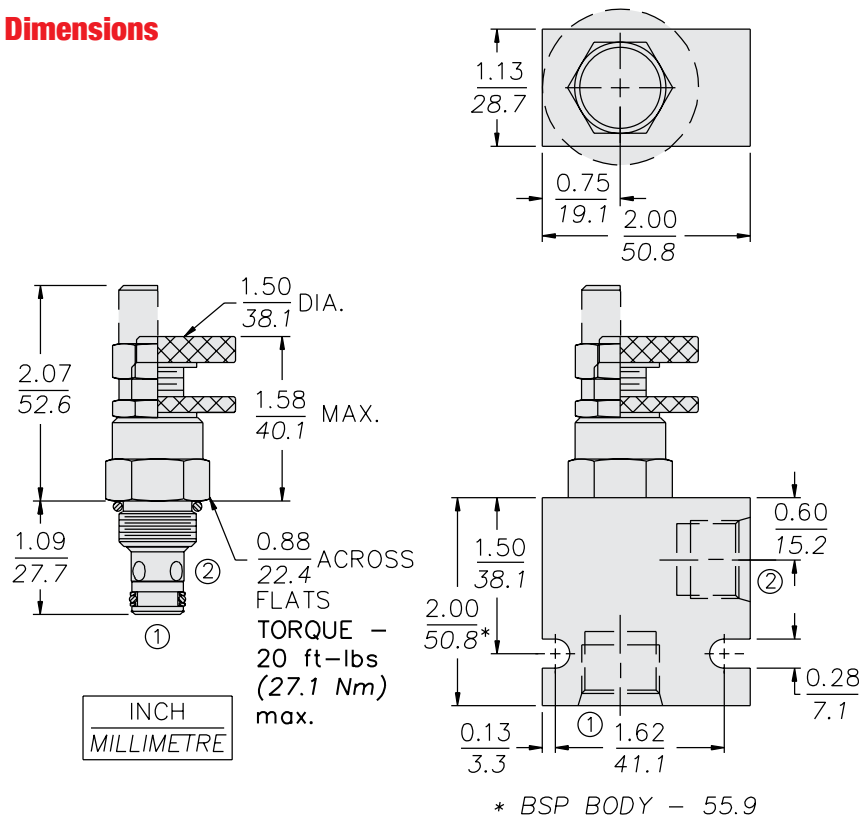

HYDRAFORCE

Materials

Cartridge:

Weight: 0.10 kg. (0.23 lbs.)
 Steel with hardened work surfaces.
 Zinc-plated exposed surfaces.
 Buna N O-rings and polyester elastomer back-ups standard.
 Anodized aluminum knobs.

Standard Ported Body:

Weight: 0.16 kg. (0.35 lbs.)
 Anodized highstrength 6061 T6 aluminum alloy, rated to 207 bar (3000 psi).
 Ductile iron bodies available; dimensions may differ.

Symbols

USASI/ISO:

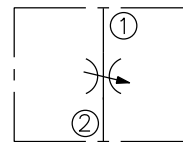

Performance

