

# Pressure Filter - PB

## 420 BAR RATED UP TO 420 LPM FLOW

**Pressure** (ISO 10771-1:2002)

Max. working: 42 MPa (420 bar)

Test: 62 MPa (620 bar)

Bursting: 126 MPa (1.260 bar)

Collapse, differential for the filter element (ISO 2941): series standard 2 MPa (20 bar)  
series H+ 21 MPa (210 bar)

**Bypass Valve**

Setting: 600 kPa (6 bar) ± 10%

**Working Temperature**

From -25° to +110° C

**Compatibility** (ISO 2943:1999)

Full with fluids: HH-HL-HM-HV-HTG (according to ISO 6743/4)

For fluids different than the above mentioned, please contact our Sales Department.



PRESSURE FILTERS

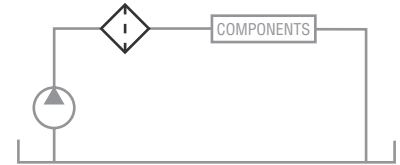

### Materials

- Head: Cast iron
- Bowl: Steel
- Bypass valve: Steel
- Seals: NBR Nitrile  
(FKM - on request fluoroelastomer)
- Indicator housing: Brass

**Application Example**



### Ordering Codes - Element

<b>E</b>	Element
----------	---------

<b>P</b>	<b>B</b>				<b>Family, Nominal Size, Length</b>	<b>11</b>	<b>12</b>	<b>13</b>	<b>21</b>	<b>22</b>	<b>31</b>	<b>32</b>	<b>33</b>	<b>34</b>	<b>35</b>
----------	----------	--	--	--	-------------------------------------	-----------	-----------	-----------	-----------	-----------	-----------	-----------	-----------	-----------	-----------

	<b>Seals</b>														
	<b>N = NBR Nitrile</b>	<b>N</b>	<b>N</b>	<b>N</b>	<b>N</b>	<b>N</b>	<b>N</b>	<b>N</b>	<b>N</b>	<b>N</b>	<b>N</b>	<b>N</b>	<b>N</b>	<b>N</b>	<b>N</b>
	<b>F = FKM Fluoroelastomer</b>	<b>F</b>	<b>F</b>	<b>F</b>	<b>F</b>	<b>F</b>	<b>F</b>	<b>F</b>	<b>F</b>	<b>F</b>	<b>F</b>	<b>F</b>	<b>F</b>	<b>F</b>	<b>F</b>

		<b>Filter Media</b>														
		<b>CC = Cellulose 10µm β&gt;2 Δp 2MPa (20 bar)</b>	<b>CC</b>	<b>CC</b>	<b>CC</b>	<b>CC</b>	<b>CC</b>	<b>CC</b>	<b>CC</b>	<b>CC</b>	<b>CC</b>	<b>CC</b>	<b>CC</b>	<b>CC</b>	<b>CC</b>	<b>Filter Bypass Recommended</b>
		<b>FA = Fibre 5µm(e) β&gt;1.000 Δp 2MPa (20 bar)</b>	<b>FA</b>	<b>FA</b>	<b>FA</b>	<b>FA</b>	<b>FA</b>	<b>FA</b>	<b>FA</b>	<b>FA</b>	<b>FA</b>	<b>FA</b>	<b>FA</b>	<b>FA</b>		
		<b>FB = Fibre 7µm(e) β&gt;1.000 Δp 2MPa (20 bar)</b>	<b>FB</b>	<b>FB</b>	<b>FB</b>	<b>FB</b>	<b>FB</b>	<b>FB</b>	<b>FB</b>	<b>FB</b>	<b>FB</b>	<b>FB</b>	<b>FB</b>	<b>FB</b>		
		<b>FC = Fibre 12µm(e) β&gt;1.000 Δp 2MPa (20 bar)</b>	<b>FC</b>	<b>FC</b>	<b>FC</b>	<b>FC</b>	<b>FC</b>	<b>FC</b>	<b>FC</b>	<b>FC</b>	<b>FC</b>	<b>FC</b>	<b>FC</b>	<b>FC</b>		
		<b>FD = Fibre 21µm(e) β&gt;1.000 Δp 2MPa (20 bar)</b>	<b>FD</b>	<b>FD</b>	<b>FD</b>	<b>FD</b>	<b>FD</b>	<b>FD</b>	<b>FD</b>	<b>FD</b>	<b>FD</b>	<b>FD</b>	<b>FD</b>	<b>FD</b>		
		<b>HA = Fibre 5µm(e) β&gt;1.000 Δp 21MPa (210 bar)</b>	<b>HA</b>	<b>HA</b>	<b>HA</b>	<b>HA</b>	<b>HA</b>	<b>HA</b>	<b>HA</b>	<b>HA</b>	<b>HA</b>	<b>HA</b>	<b>HA</b>	<b>HA</b>	<b>Does not require Bypass</b>	
		<b>HB = Fibre 7µm(e) β&gt;1.000 Δp 21MPa (210 bar)</b>	<b>HB</b>	<b>HB</b>	<b>HB</b>	<b>HB</b>	<b>HB</b>	<b>HB</b>	<b>HB</b>	<b>HB</b>	<b>HB</b>	<b>HB</b>	<b>HB</b>			
		<b>HC = Fibre 12µm(e) β&gt;1.000 Δp 21MPa (210 bar)</b>	<b>HC</b>	<b>HC</b>	<b>HC</b>	<b>HC</b>	<b>HC</b>	<b>HC</b>	<b>HC</b>	<b>HC</b>	<b>HC</b>	<b>HC</b>	<b>HC</b>			
		<b>HD = Fibre 21µm(e) β&gt;1.000 Δp 21MPa (201 bar)</b>	<b>HD</b>	<b>HD</b>	<b>HD</b>	<b>HD</b>	<b>HD</b>	<b>HD</b>	<b>HD</b>	<b>HD</b>	<b>HD</b>	<b>HD</b>	<b>HD</b>			

# Pressure Filter - PB

**420 BAR RATED UP TO 420 LPM FLOW**

## Ordering Codes - Filter

<input type="checkbox"/>		<b>Type</b>												
		F = Filter Complete	F	F	F	F	F	F	F	F	F	F	F	F
		B = Filter Housing	B	B	B	B	B	B	B	B	B	B	B	B
<input type="checkbox"/>	<input type="checkbox"/>	<b>Family, Nominal Size, Length</b>	11	12	13	21	22	31	32	33	34	35		

<input type="checkbox"/>		<b>Port Type</b>												
		B = BSP Thread	B	B	B	B	B	B	B	B	B	B	B	B
		N = NPT Thread	N	N	N	N	N	N	N	N	N	N	N	N
		S = SAE Thread	S	S	S	S	S	S	S	S	S	S	S	S
		F = SAE flanged 3000 psi	-	-	-	F	F	F	F	F	F	F	F	F
		G = SAE flanged 6000 psi	-	-	-	G	G	G	G	G	G	G	G	G

<input type="checkbox"/>	<input type="checkbox"/>	<b>Port Size</b>												
		04 = 1/2" (N04 not available)	04	04	04	-	-	-	-	-	-	-	-	-
		06 = 3/4"	06	06	06	06	06	-	-	-	-	-	-	-
		08 = 1" (G08 not available, F08 for PB2+ only)	-	-	-	08	08	08	08	08	08	08	08	08
		10 = 1 1/4"	-	-	-	-	-	10	10	10	10	10	10	10
		12 = 1 1/2" (G12 option not available)	-	-	-	-	-	12	12	12	12	12	12	12

<input type="checkbox"/>	<input type="checkbox"/>	<b>Bypass Valve</b>												
		W = Without	W	W	W	W	W	W	W	W	W	W	W	W
		C = 600 kPa (6 bar)	C	C	C	C	C	C	C	C	C	C	C	C
		R = Reverse flow valve	-	-	-	R	R	R	R	R	R	R	R	R
		P = Reverse flow + bypass valve	-	-	-	P	P	P	P	P	P	P	P	P

On request

<input type="checkbox"/>	<input type="checkbox"/>	<b>Seals</b>												
		N = NBR Nitrile	N	N	N	N	N	N	N	N	N	N	N	N
		F = FKM Fluoroelastomer	F	F	F	F	F	F	F	F	F	F	F	F

<input type="checkbox"/>	<input type="checkbox"/>	<b>Filter Media</b>												
		CC = Cellulose 10µm β>2 Δp 2MPa (20 bar)	CC	CC	CC	CC	CC	CC	CC	CC	CC	CC	CC	CC
		FA = Fibre 5µm(ε) β>1.000 Δp 2MPa (20 bar)	FA	FA	FA	FA	FA	FA	FA	FA	FA	FA	FA	FA
		FB = Fibre 7µm(ε) β>1.000 Δp 2MPa (20 bar)	FB	FB	FB	FB	FB	FB	FB	FB	FB	FB	FB	FB
		FC = Fibre 12µm(ε) β>1.000 Δp 2MPa (20 bar)	FC	FC	FC	FC	FC	FC	FC	FC	FC	FC	FC	FC
		FD = Fibre 21µm(ε) β>1.000 Δp 2MPa (20 bar)	FD	FD	FD	FD	FD	FD	FD	FD	FD	FD	FD	FD
		HA = Fibre 5µm(ε) β>1.000 Δp 21MPa (20 bar)	HA	HA	HA	HA	HA	HA	HA	HA	HA	HA	HA	HA
		HB = Fibre 7µm(ε) β>1.000 Δp 21MPa (20 bar)	HB	HB	HB	HB	HB	HB	HB	HB	HB	HB	HB	HB
		HC = Fibre 12µm(ε) β>1.000 Δp 21MPa (20 bar)	HC	HC	HC	HC	HC	HC	HC	HC	HC	HC	HC	HC
		HD = Fibre 21µm(ε) β>1.000 Δp 21MPa (20 bar)	HD	HD	HD	HD	HD	HD	HD	HD	HD	HD	HD	HD

<input type="checkbox"/>	<input type="checkbox"/>	<b>Clogging Indicator</b>												
		03 = port, plugged	03	03	03	03	03	03	03	03	03	03	03	03
		5E = visual differential 500 kPa (5 bar)	5E	5E	5E	5E	5E	5E	5E	5E	5E	5E	5E	5E
		5F = visual differential 800 kPa (8 bar)	5F	5F	5F	5F	5F	5F	5F	5F	5F	5F	5F	5F
		6E = electrical differential 500 kPa (5 bar)	6E	6E	6E	6E	6E	6E	6E	6E	6E	6E	6E	6E
		6F = electrical differential 800 kPa (8 bar)	6F	6F	6F	6F	6F	6F	6F	6F	6F	6F	6F	6F
		7E = indicator 6E with LED	7E	7E	7E	7E	7E	7E	7E	7E	7E	7E	7E	7E
		7F = indicator 6F with LED	7F	7F	7F	7F	7F	7F	7F	7F	7F	7F	7F	7F
		T2 = elect. diff. 500 kPa (5bar) with thermostat 30°C	T2	T2	T2	T2	T2	T2	T2	T2	T2	T2	T2	T2
		T3 = elect. diff. 800 kPa (8bar) with thermostat 30°C	T3	T3	T3	T3	T3	T3	T3	T3	T3	T3	T3	T3

<input type="checkbox"/>	<input type="checkbox"/>	<b>Accessories XX = no access available</b>	XX	XX	XX	XX	XX	XX	XX	XX	XX	XX	XX	XX
--------------------------	--------------------------	---	----	----	----	----	----	----	----	----	----	----	----	----

# Pressure Filter - PB

HOUSINGS						
Body Size	Connection	Article No	Flow Rate Max Lpm	Price £	Price €	
FPB11	1/2"	FPB11	65 LPM	ON REQUEST		
FPB12	3/4"	FPB12	85 LPM	ON REQUEST		
FPB13	3/4"	FPB13	85 LPM	ON REQUEST		
FPB21	3/4"	FPB21	85 LPM	ON REQUEST		
FPB22	1"	FPB22	130 LPM	ON REQUEST		Body without bypass valve
FPB31	1"	FPB31	150 LPM	ON REQUEST		
FPB32	1 1/4"	FPB32	340 LPM	ON REQUEST		
FPB33	1 1/4"	FPB33	340 LPM	ON REQUEST		
FPB34	1 1/2"	FPB34	420 LPM	ON REQUEST		
FPB35	1 1/2"	FPB35	420 LPM	ON REQUEST		
FPB11	1/2"	FPB11B	65 LPM	ON REQUEST		
FPB12	3/4"	FPB12B	85 LPM	ON REQUEST		
FPB13	3/4"	FPB13B	85 LPM	ON REQUEST		
FPB21	3/4"	FPB21B	85 LPM	ON REQUEST		
FPB22	1"	FPB22B	130 LPM	ON REQUEST		Body with 6 BAR bypass valve
FPB31	1"	FPB31B	150 LPM	ON REQUEST		
FPB32	1 1/4"	FPB32B	340 LPM	ON REQUEST		
FPB33	1 1/4"	FPB33B	340 LPM	ON REQUEST		
FPB34	1 1/2"	FPB34B	420 LPM	ON REQUEST		
FPB35	1 1/2"	FPB35B	420 LPM	ON REQUEST		

**FOR ELEMENT PART NUMBER**

**E** - ELEMENT

**PB** - FILTER FAMILY SERIES

**11** - FILTER HOUSING SIZE

**CC** - ELEMENT MEDIA

Example:  
Part **EPB11CC** : element in 10 micron cellulose media for a size "11" housing

ELEMENT to be added							
Element	Filtration		Size 11	Size 12	Size 13	Size 21	Size 22
FA	5 micron				ON REQUEST		
FB	7 micron	20 BAR COLLAPSE PRESSURE A BYPASS HOUSING MUST BE USED			ON REQUEST		
FC	12 micron				ON REQUEST		
FD	21 micron				ON REQUEST		
CC	10 micron				ON REQUEST		
HA	5 micron	210 BAR COLLAPSE PRESSURE NON BYPASS HOUSING CAN BE USED			ON REQUEST		
HB	7 micron				ON REQUEST		
HC	12 micron				ON REQUEST		
HD	21 micron				ON REQUEST		
Element	Filtration		Size 31	Size 32	Size 33	Size 34	Size 35
FA	5 micron				ON REQUEST		
FB	7 micron	20 BAR COLLAPSE PRESSURE A BYPASS HOUSING MUST BE USED			ON REQUEST		
FC	12 micron				ON REQUEST		
FD	21 micron				ON REQUEST		
CC	10 micron				ON REQUEST		
HA	5 micron	210 BAR COLLAPSE PRESSURE NON BYPASS HOUSING CAN BE USED			ON REQUEST		
HB	7 micron				ON REQUEST		
HC	12 micron				ON REQUEST		
HD	21 micron				ON REQUEST		

For flowrates please refer to the clean filter pressure drop flow rate tables

CLOGGING INDICATOR				
Description	Code for 5 BAR	Code for 8 BAR	Price £	Price €
NONE - PLUGGED		03		ON REQUEST
VISUAL POP UP	5E	5F		ON REQUEST
ELECTRICAL	6E	6F		ON REQUEST
ELECTRICAL WITH LED	7E	7F		ON REQUEST
ELECTRICAL WITH THERMOSTAT	T2	T3		ON REQUEST
VISUAL & ELECTRICAL	72	73		ON REQUEST

Pressure Filter - PB

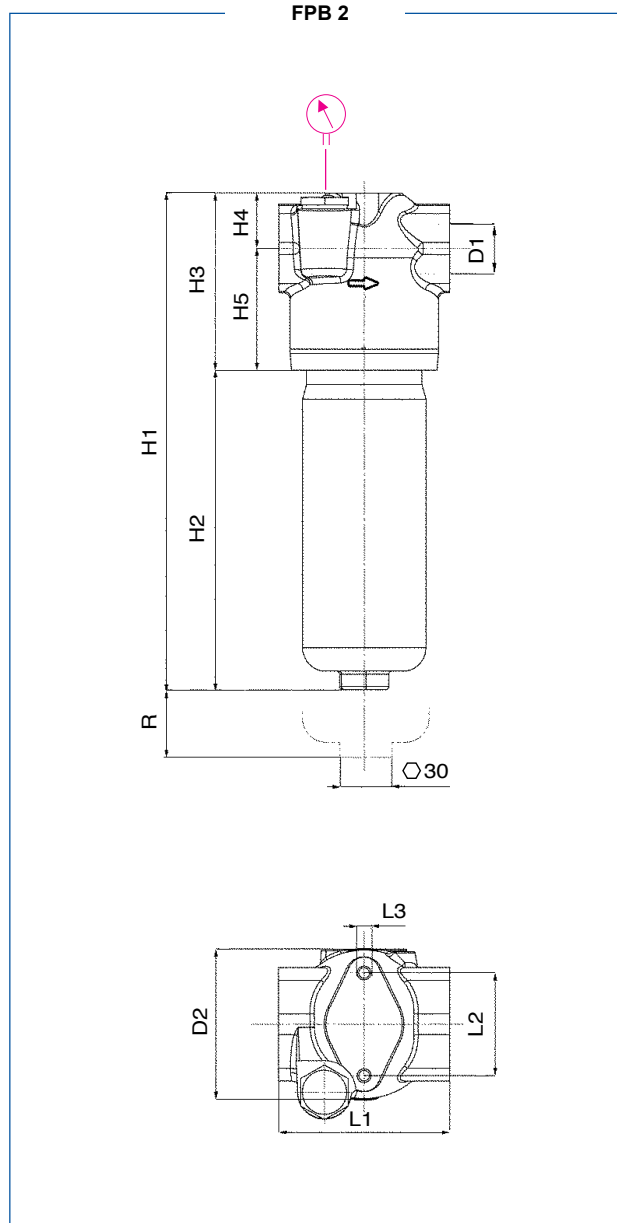
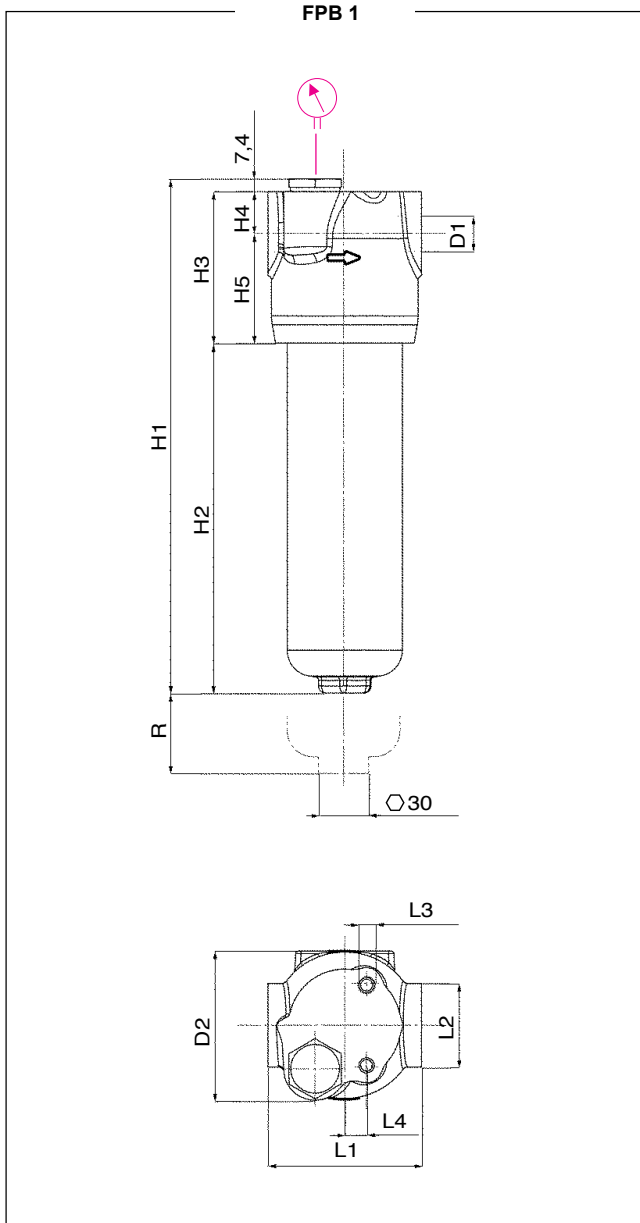

FILTER HOUSING

	D1	D2	H1	H2	H3	H4	H5	L1	L2	L3	L4	R	kg
FPB11	1/2"-3/4"	86	166	79	87	24	63	88	46	M8	12.5	100	4.4
FPB12	1/2"-3/4"	86	196	109	87	24	63	88	46	M8	12.5	100	4.6
FPB13	1/2"-3/4"	86	296	209	87	24	63	88	46	M8	12.5	100	5.2
FPB21	3/4" - 1"	94	226	116	112	35	77	108	65	M8	-	100	6.6
FPB22	3/4" - 1"	94	317	207	112	35	77	108	65	M8	-	100	8.2

FILTER ELEMENT

	A	B	C	kg		Area (cm <sup>2</sup> )		
				media F+ & C+	media H+	media F+	media H+	media C+
EPB11	45	25	85	0.15	0.25	355	340	310
EPB12	45	25	116	0.20	0.55	500	475	435
EPB13	45	25	211	0.30	0.45	935	915	815
EPB21	52	23.5	115	0.25	0.40	975	975	780
EPB22	52	23.5	210	0.35	0.55	1.830	1.785	1.465

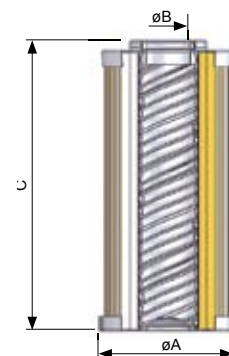

# Pressure Filter - PB

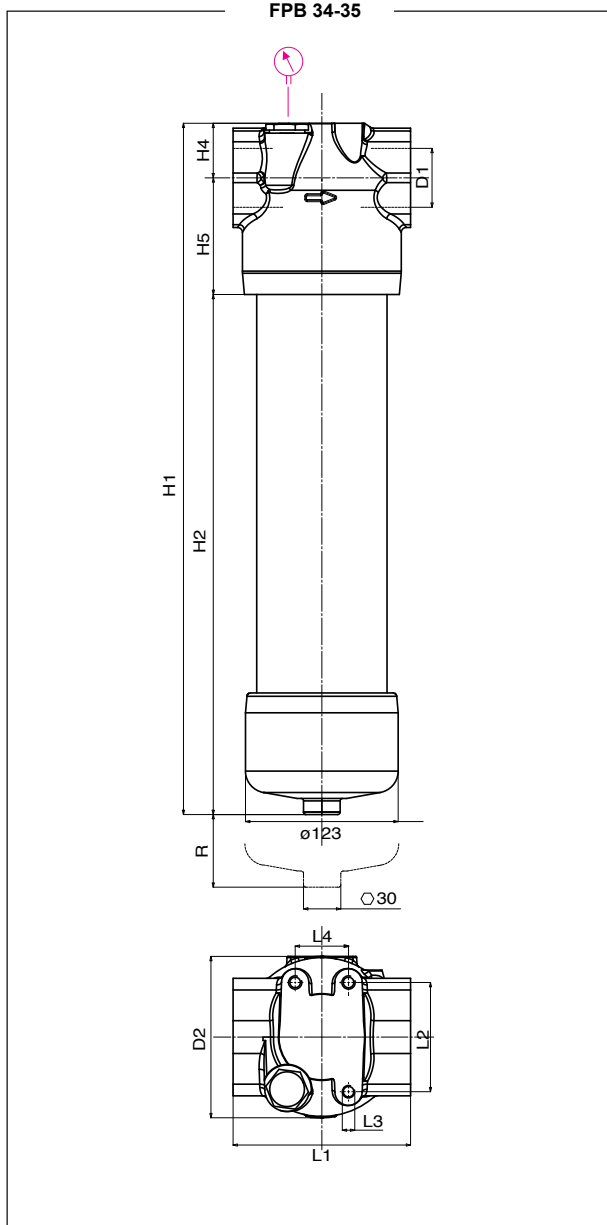
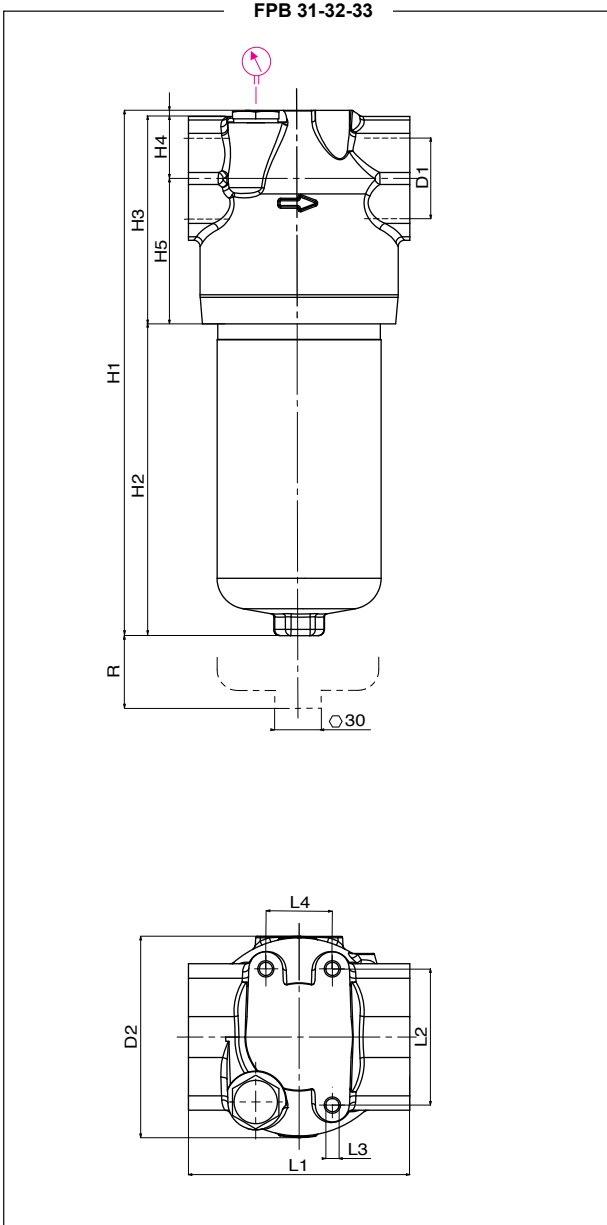

**FILTER HOUSING**

	D1	D2	H1	H2	H3	H4	H5	L1	L2	L3	L4	R	kg
FPB31		128	245	107	138	44	94	143	88	M10	43	100	11.0
FPB32		128	337	199	138	44	94	143	88	M10	43	100	13.9
FPB33	1" - 11/4" - 11/2"	128	457	319	138	44	94	143	88	M10	43	100	17.2
FPB34		128	558	420	138	44	94	143	88	M10	43	100	22.0
FPB35		128	685	520	138	44	94	143	88	M10	43	100	25.0

**FILTER ELEMENT**

	A	B	C	kg					Area (cm <sup>2</sup> )		
				media F+ & C+	media H+	media F+	media H+	media C+	media F+	media H+	media C+
EPB31	78	42.5	118	0.40	0.70	2.000	1.470	1.720			
EPB32	78	42.5	210	0.80	1.30	3.695	2.695	3.170			
EPB33	78	42.5	330	1.00	1.60	5.025	4.325	4.025			
EPB34	78	42.5	430	1.20	1.80	6.585	5.685	6.585			
EPB35	78	42.5	530	1.40	2.00	8.145	7.045	8.645			

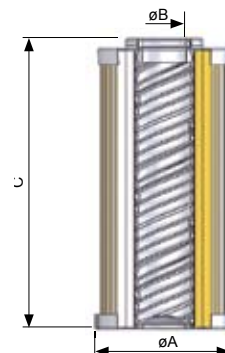

# Pressure Filter - PB

## FLUID SPEED

(when selecting the filter size, we suggest to consider also the max recommended fluid speed (in pressure lines normally  $5 < v < 10$  m/s).

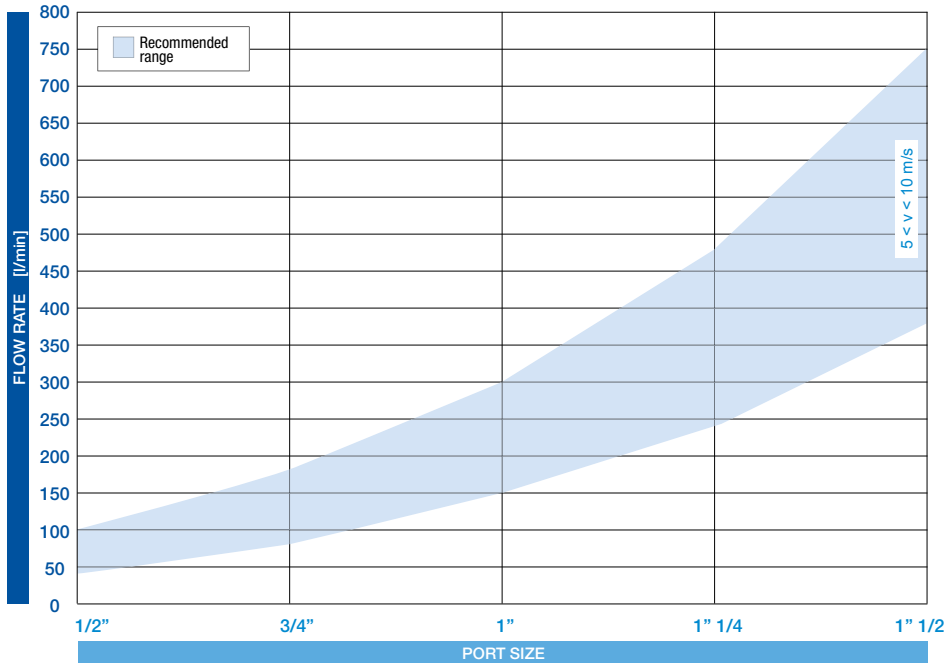

## PRESSURE DROP CURVES ( $\Delta p$ )

The “Assembly Pressure Drop ( $\Delta p$ )” is obtained by adding the pressure drop values of the Filter Housing and of the Clean Filter Element corresponding to the considered Flow Rate and it must be lower than 120 kPa (1,2 bar).

### FILTER HOUSING PRESSURE DROP

(mainly depending on the port size)

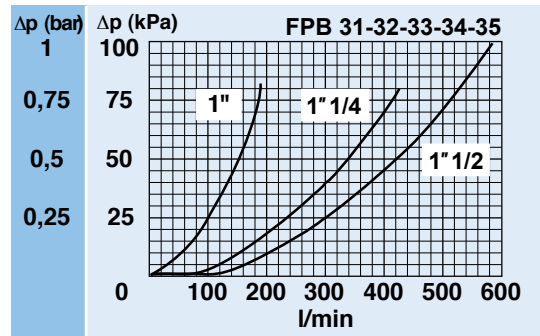
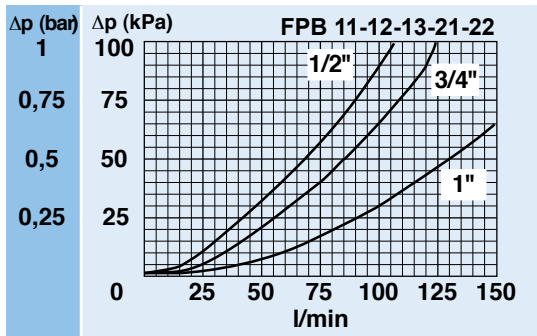

### CLEAN FILTER ELEMENT PRESSURE DROP WITH F+ AND C+ MEDIA

(depending both on the internal diameter of the element and on the filter media)

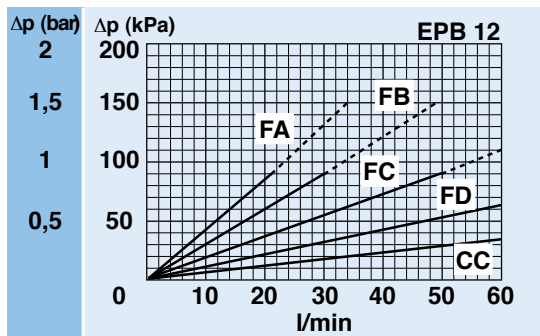
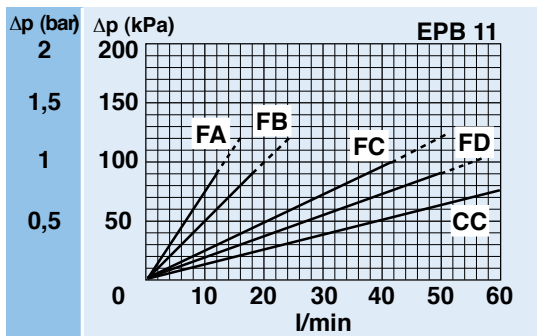

# Pressure Filter - PB

CLEAN FILTER ELEMENT PRESSURE DROP WITH F+ AND C+ MEDIA  
 (depending both on the internal diameter of the element and on the filter media)

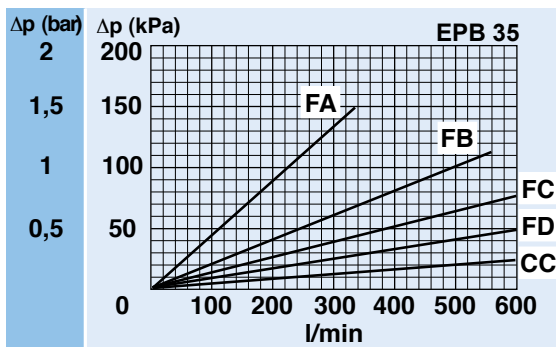
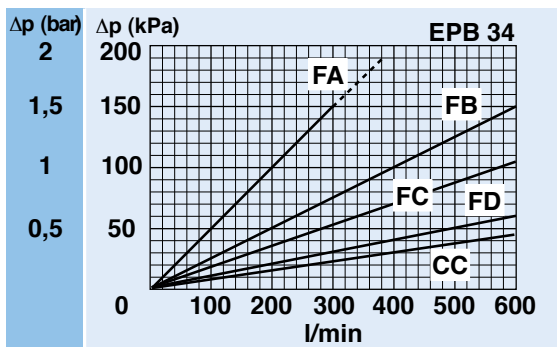
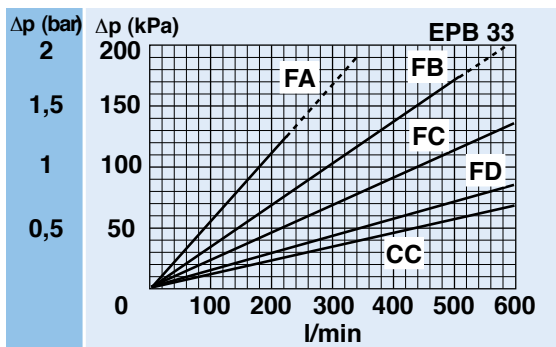
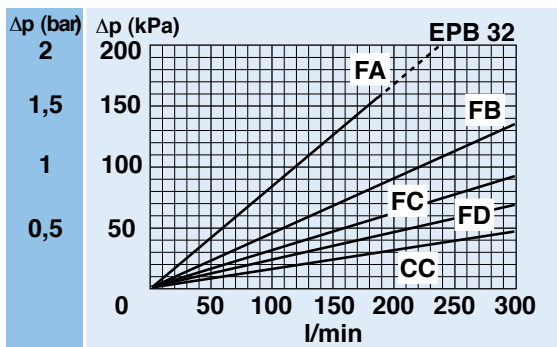
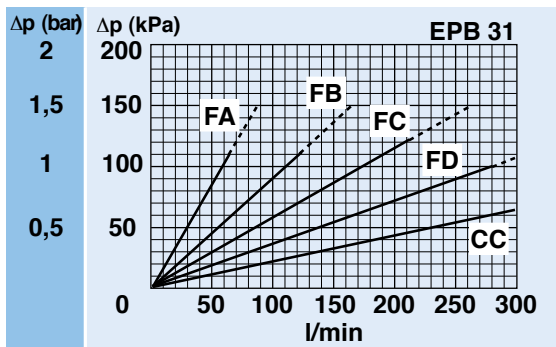
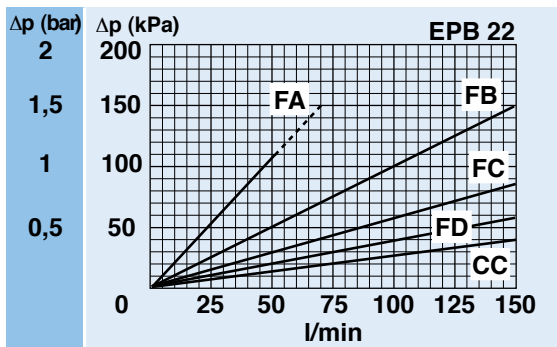
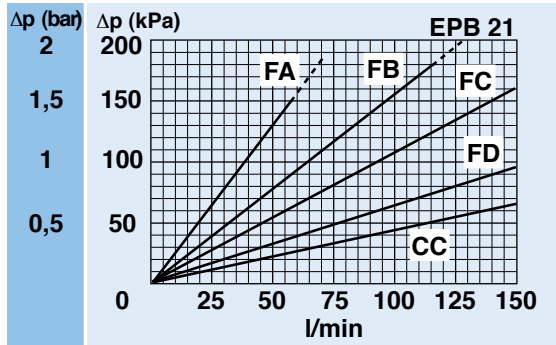
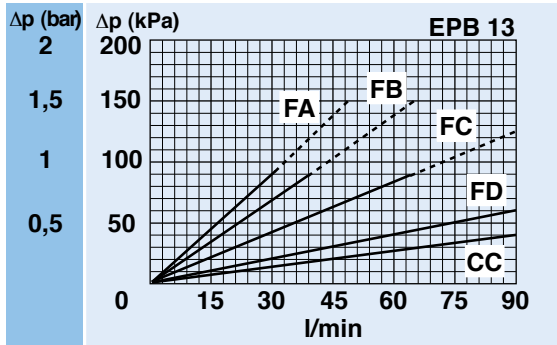

## Pressure Filter - PB

### PRESSURE DROP CURVES ( $\Delta p$ )

The "Assembly Pressure Drop ( $\Delta p$ )" is obtained by adding the pressure drop values of the Filter Housing and of the Clean Filter Element corresponding to the considered Flow Rate and it must be lower than 120 kPa (1,2 bar).

### CLEAN FILTER ELEMENT PRESSURE DROP

(depending both on the internal diameter of the element and on the filter media)

#### WITH H+ MEDIA

(recommended with no bypass option)

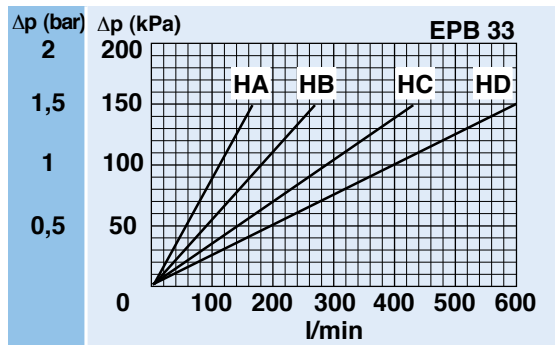
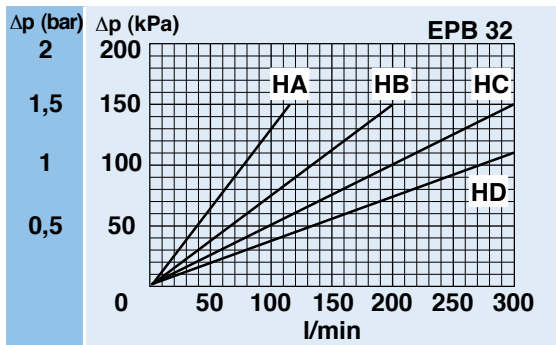
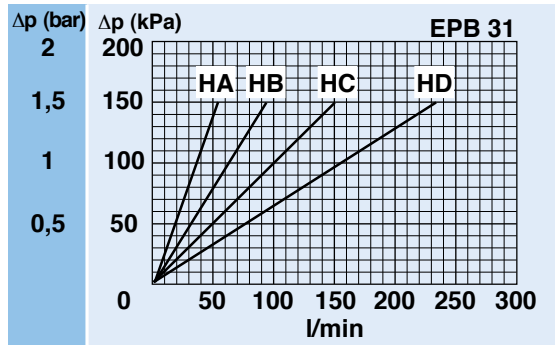
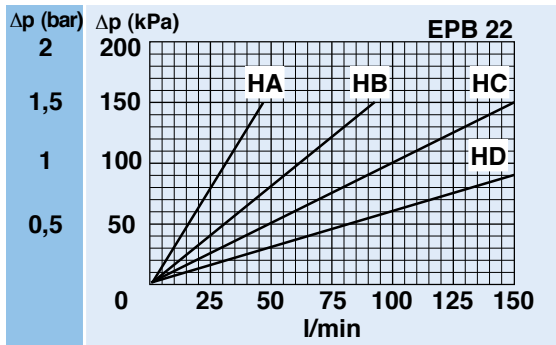
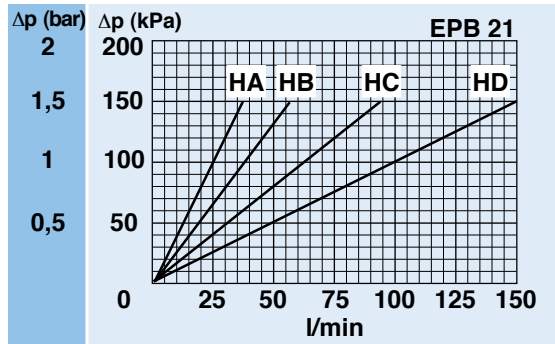
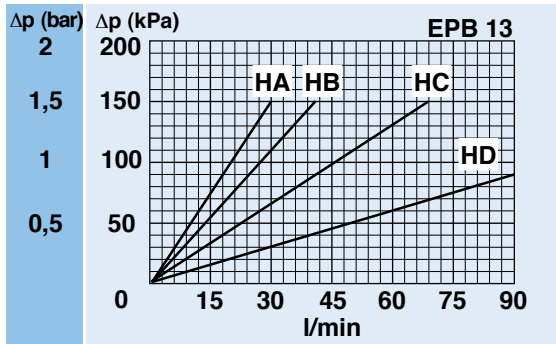
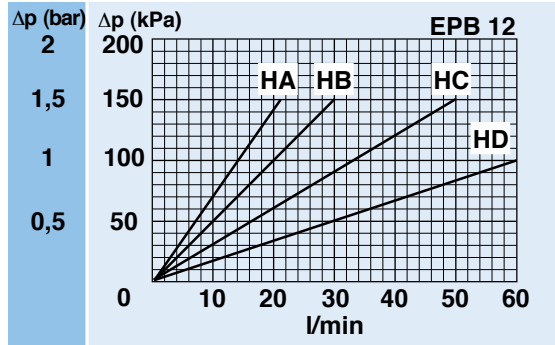
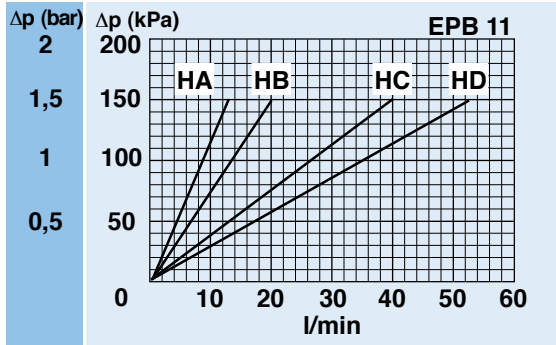



# Pressure Filter - PB

## CLEAN FILTER ELEMENT PRESSURE DROP

(depending both on the internal diameter of the element and on the filter media)

### WITH H+ MEDIA

(recommended with no bypass option)

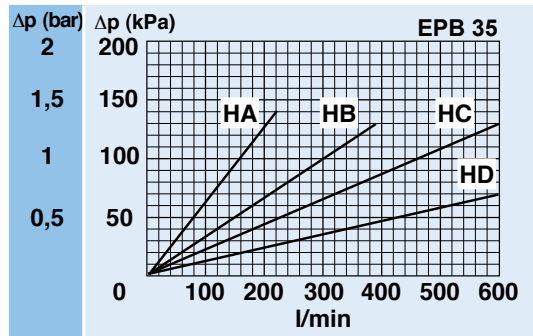
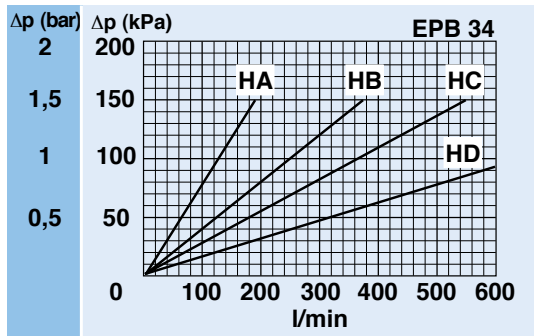

## BYPASS VALVE PRESSURE DROP

When selecting the filter size, these curves must be taken into account if it is foreseen that any flow peak is to be absorbed by the bypass valve, it also must be of proper configuration to avoid pressure peaks. The valve pressure drop is directly proportional to fluid specific gravity.

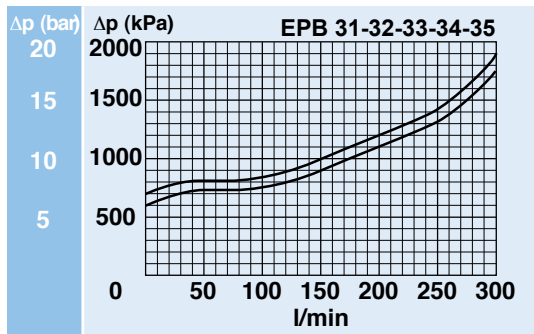
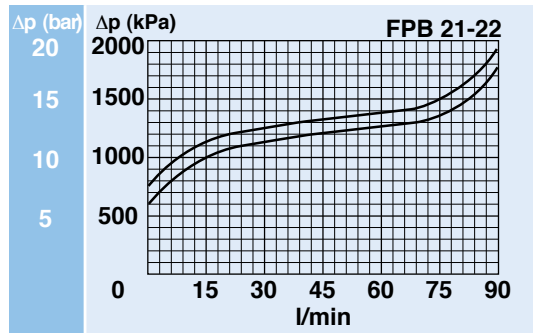
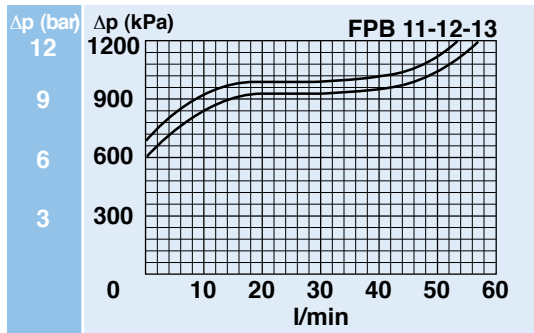

N.B. All the curves have been obtained with mineral oil having a kinematic viscosity 30 cSt and specific gravity 0,9 kg/dm<sup>3</sup>; for fluids with different features, please consider the factors described in the first part of this catalogue. All the curves are obtained from test done at the UFI HYDRAULIC DIVISION Laboratory, according to the specification ISO 3968:2005. In case of discrepancy, please check the contamination level, viscosity and features of the fluid in use.

## REVERSE FLOW VALVE

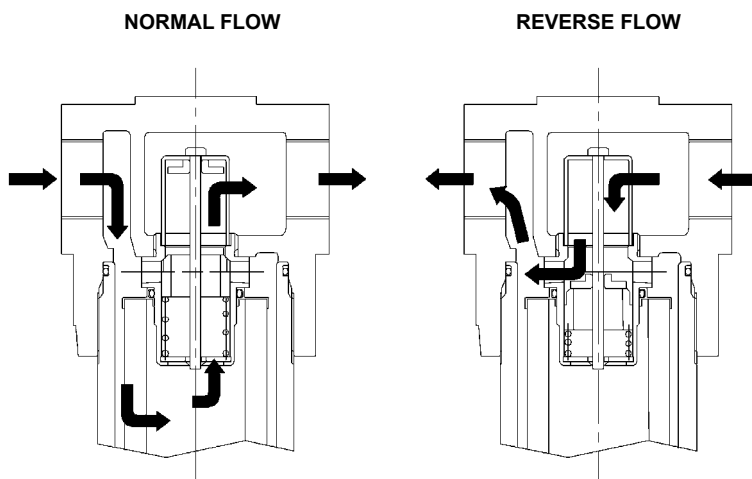

For hydraulic systems where reverse flow can occur, the pressure filters series FPB2+ and FPB3+ are available with a free reverse flow valve allowing the fluid to pass through the filter element in the normal direction and to bypass the filter element in the reverse direction (option "R"). The reverse flow valve is available also with incorporated bypass valve for the normal flow direction, set at 6 bar (option "P").

In normal flow conditions the whole flow pass through the filter element. In the option "P", if the differential pressure across the element exceeds 6 bar the bypass is activated.

In reverse flow conditions the flow bypasses the filter element.

### Pressure drop through the valve in the reverse direction:

- 0,4 bar at 100 L/min
- 0,6 bar at 200 L/min
- 0,8 bar at 300 L/min

## Pressure Filter - PB

### CLOGGING INDICATOR

A visual or visual-electrical differential indicator is available as an option and allows monitoring of the element conditions, giving an exact indication of the right time to replace the element.

### FILTER HOUSING

The head by high performance cast iron and the bowl by extruded steel ensure the best fatigue resistance to the working pressures.

### FILTER ELEMENT

The filter element is manufactured with filter medias selected in the UFI laboratory and mechanically supported to maintain the highest performance even at high differential pressures.

### SEAL GUARANTEED

A perfect O-ring seal is always ensured as it is not dependent on the tightening torque applied to the bowl.

### EASY MAINTENANCE

The hexagon end of the bowl allows for easy maintenance by using a simple hexagon wrench.

### CLOGGING INDICATOR



Differential

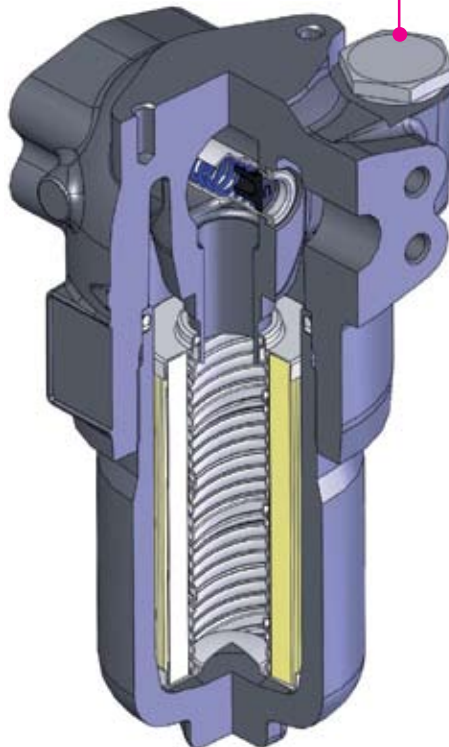

### SPARE SEAL KIT

	NBR	FKM
FPB11	521.0002.2	521.0086.2
FPB12	521.0002.2	521.0086.2
FPB13	521.0002.2	521.0086.2
FPB21	521.0003.2	521.0030.2
FPB22	521.0003.2	521.0030.2
FPB31	521.0004.2	521.0087.2
FPB32	521.0004.2	521.0087.2
FPB33	521.0004.2	521.0087.2
FPB34	521.0004.2	521.0087.2
FPB35	521.0004.2	521.0087.2

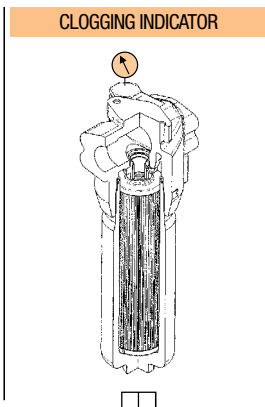
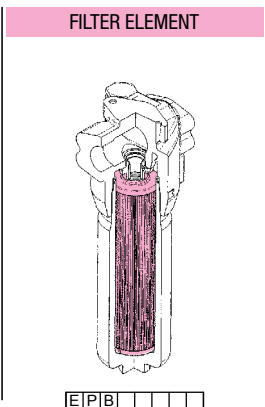
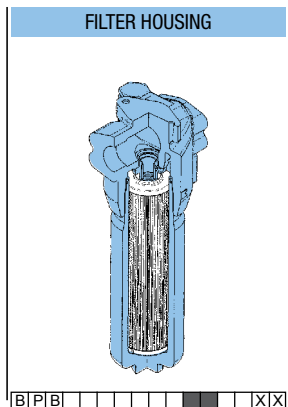

**SPARE PARTS ELEMENTS**  
(For filling up see table "Ordering and option chart")