

## PD10-44

### Piloted 2-Way Spool, 207 BAR Rated

A screw-in, cartridge-style, pilot-operated, spool-type, hydraulic directional valve for three-way circuits requiring remote pilot actuation.

Porting	Hydraforce code	Article no.	Bias Spring Options	Price £	Price €
Cartridge Version	PD10-44-0-NS*	<b>PD10440C*</b>		<b>£71.10</b>	<b>€85.30</b>
INLINE 1/4" BSP	PD10-44-2B-NS*	<b>PD10442B*</b>	* suffix with 110 = 7.6 BAR (110 PSI) 170 = 11.7 BAR (170 PSI)	<b>£133.30</b>	<b>€159.90</b>
INLINE 3/8" BSP	PD10-44-3B-NS*	<b>PD10443B*</b>		<b>£128.40</b>	<b>€154.10</b>

with nitril seals / Viton on request

### Materials

#### Cartridge:

Weight: 0.16 kg. (0.35 lbs.)  
Steel with hardened work surfaces.  
Zinc-plated exposed surfaces.  
Buna N O-rings and polyester elastomer back-ups standard.

#### Standard Ported Body:

Weight: 0.34 kg. (0.75 lbs.)  
Anodized highstrength 6061 T6 aluminum alloy, rated to 207 bar (3000 psi).  
Ductile iron bodies available; dimensions may differ.

### Dimensions

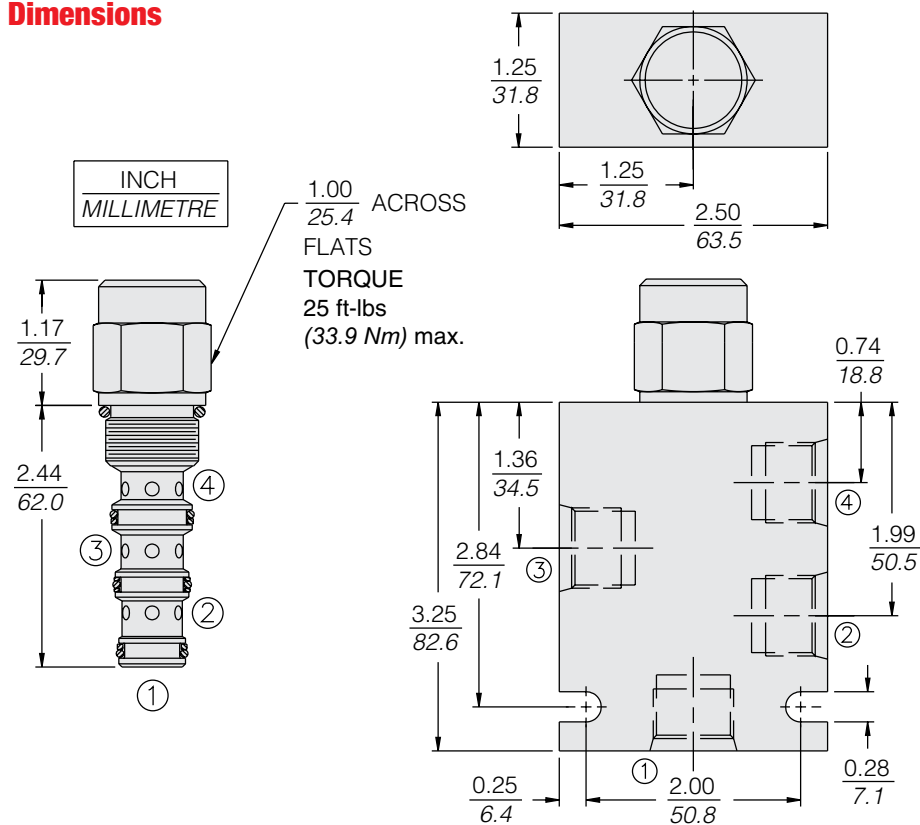

### Symbols

#### USASI

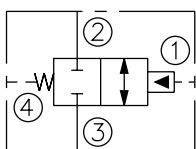

#### ISO:

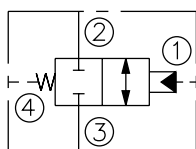

### Performance

