

Pressure Filter - PL

Pressure (ISO 10771-1:2002)

Max working: 31,5 MPa (315 bar)

Test: 47 MPa (470 bar)

Bursting: 95 MPa (950 bar)

Collapse, differential for the filter element (ISO 2941): series standard: 2 MPa (20 bar)

series H+: 21 MPa (210 bar)

Bypass Valve

Setting: 600 kPa (6 bar) ± 10%

Working Temperature

From -25° to +110° C

Compatibility (ISO 2943:1999)

Full with fluids: HH-HL-HM-HV-HTG (according to ISO 6743/4)

For fluids different than the above mentioned, please contact our Sales Department.



PRESSURE FILTERS

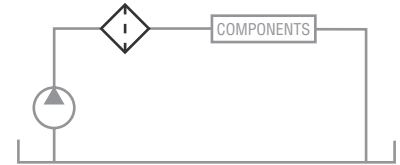

Application Example



Materials

Head: Cast iron
 Bowl: Steel
 Bypass valve: Steel
 Seals: NBR Nitrile (FKM - on request fluoroelastomer)
 Indicator housing: Brass

HOUSINGS				
Body Size	Flow Rate Max Lpm	Price £	Price €	
FPL11	65	ON REQUEST		
FPL12	65	ON REQUEST		
FPL13	65	ON REQUEST		Body without bypass valve
FPL21	85	ON REQUEST		
FPL22	85	ON REQUEST		
FPL11B	65	ON REQUEST		
FPL12B	65	ON REQUEST		Body with 6 BAR bypass valve
FPL13B	65	ON REQUEST		
FPL21B	85	ON REQUEST		
FPL22B	85	ON REQUEST		

ELEMENT to be added							
Element	Filtration		Size 11	Size 12	Size 13	Size 21	Size 22
FA	5 micron				ON REQUEST		
FB	7 micron	20 BAR COLLAPSE			ON REQUEST		
FC	12 micron	PRESSURE A			ON REQUEST		
FD	21 micron	BYPASS HOUSING			ON REQUEST		
CC	10 micron	MUST BE USED			ON REQUEST		
HA	5 micron				ON REQUEST		
HB	7 micron	210 BAR COLLAPSE			ON REQUEST		
HC	12 micron	PRESSURE NON			ON REQUEST		
HD	21 micron	BYPASS HOUSING			ON REQUEST		
		CAN BE USED			ON REQUEST		

For flowrates please refer to the clean filter pressure drop flow rate tables

CLOGGING INDICATOR					
Description	Code for 5 BAR	Code for 8 BAR	Price £	Price €	
NONE - PLUGGED		03		ON REQUEST	
VISUAL POP UP	5E	5F		ON REQUEST	
ELECTRICAL	6E	6F		ON REQUEST	
ELECTRICAL WITH LED	7E	7F		ON REQUEST	
ELECTRICAL WITH THERMOSTAT	T2	T3		ON REQUEST	
VISUAL & ELECTRICAL	72	73		ON REQUEST	

FOR ELEMENT PART NUMBER	
E	- ELEMENT
PB	- FILTER FAMILY SERIES
11	- FILTER HOUSING SIZE
CC	- ELEMENT MEDIA

Example:
 Part **EPB11CC** : element in 10 micron cellulose media for a size "11" housing



Pressure Filter - PL

Ordering Codes - Filter

<input type="checkbox"/>		Type						
		F = Filter Complete	F	F	F	F	F	F
		B = Filter Housing	B	B	B	B	B	B
<input type="checkbox"/>	<input type="checkbox"/>	Family, Nominal Size, Length	11	12	13	21	22	
<input type="checkbox"/>		Port Type						
		C = flanged 90° (manifold)	C	C	C	C	C	C
<input type="checkbox"/>	<input type="checkbox"/>	Port Size						
		15 = size 15	15	15	15	-	-	
		20 = size 20	-	-	-	20	20	
<input type="checkbox"/>		Bypass Valve - not available						
		W = without	W	W	W	W	W	W
		C = 600 kPa (6 bar)	C	C	C	C	C	C
<input type="checkbox"/>		Seals						
		N = NBR Nitrile	N	N	N	N	N	N
		F = FKM Fluoroelastomer	F	F	F	F	F	F
<input type="checkbox"/>	<input type="checkbox"/>	Filter Media						
		CC = Cellulose 10µm β>2 Δp 2MPa (20 bar)	CC	CC	CC	CC	CC	CC
		FA = Fibre 5µm(e) β>1.000 Δp 2MPa (20 bar)	FA	FA	FA	FA	FA	FA
		FB = Fibre 7µm(e) β>1.000 Δp 2MPa (20 bar)	FB	FB	FB	FB	FB	FB
		FC = Fibre 12µm(e) β>1.000 Δp 2MPa (20 bar)	FC	FC	FC	FC	FC	FC
		FD = Fibre 21µm(e) β>1.000 Δp 2MPa (20 bar)	FD	FD	FD	FD	FD	FD
		HA = Fibre 5µm(e) β>1.000 Δp 21MPa (210 bar)	HA	HA	HA	HA	HA	HA
		HB = Fibre 7µm(e) β>1.000 Δp 21MPa (210 bar)	HB	HB	HB	HB	HB	HB
		HC = Fibre 12µm(e) β>1.000 Δp 21MPa (210 bar)	HC	HC	HC	HC	HC	HC
		HD = Fibre 21µm(e) β>1.000 Δp 21MPa (210 bar)	HD	HD	HD	HD	HD	HD
<input type="checkbox"/>	<input type="checkbox"/>	Clogging Indicator						
		03 = port, plugged	03	03	03	03	03	03
		5E = visual differential 500 kPa (5 bar)	5E	5E	5E	5E	5E	5E
		5F = visual differential 800 kPa (8 bar)	5F	5F	5F	5F	5F	5F
		6E = electrical differential 500 kPa (5 bar)	6E	6E	6E	6E	6E	6E
		6F = electrical differential 800 kPa (8 bar)	6F	6F	6F	6F	6F	6F
		7E = indicator 6E with LED	7E	7E	7E	7E	7E	7E
		7F = indicator 6F with LED	7F	7F	7F	7F	7F	7F
		T2 = elect. diff. 500 kPa (5bar) with thermostat 30°C	T2	T2	T2	T2	T2	T2
		T3 = elect. diff. 800 kPa (8bar) with thermostat 30°C	T3	T3	T3	T3	T3	T3
<input type="checkbox"/>	<input type="checkbox"/>	Accessories XX = no access available	XX	XX	XX	XX	XX	XX

Pressure Filter - PL

Ordering Codes - Element

E	Element								
P	B	Family, Nominal Size, Length			11	12	13	21	22
		Seals							
		N = NBR Nitrile			N	N	N	N	N
		F = FKM Fluoroelastomer			F	F	F	F	F
		Filter Media							
		CC = Cellulose 10 μ m $\beta > 2$ Δp 2MPa (20 bar)			CC	CC	CC	CC	CC
		FA = Fibre 5 μ m ^(e) $\beta > 1.000$ Δp 2MPa (20 bar)			FA	FA	FA	FA	FA
		FB = Fibre 7 μ m ^(e) $\beta > 1.000$ Δp 2MPa (20 bar)			FB	FB	FB	FB	FB
		FC = Fibre 12 μ m ^(e) $\beta > 1.000$ Δp 2MPa (20 bar)			FC	FC	FC	FC	FC
		FD = Fibre 21 μ m ^(e) $\beta > 1.000$ Δp 2MPa (20 bar)			FD	FD	FD	FD	FD
		HA = Fibre 5 μ m ^(e) $\beta > 1.000$ Δp 21MPa (210 bar)			HA	HA	HA	HA	HA
		HB = Fibre 7 μ m ^(e) $\beta > 1.000$ Δp 21MPa (210 bar)			HB	HB	HB	HB	HB
		HC = Fibre 12 μ m ^(e) $\beta > 1.000$ Δp 21MPa (210 bar)			HC	HC	HC	HC	HC
		HD = Fibre 21 μ m ^(e) $\beta > 1.000$ Δp 21MPa (210 bar)			HD	HD	HD	HD	HD



PRESSURE FILTERS

FPL 1

FPL 2

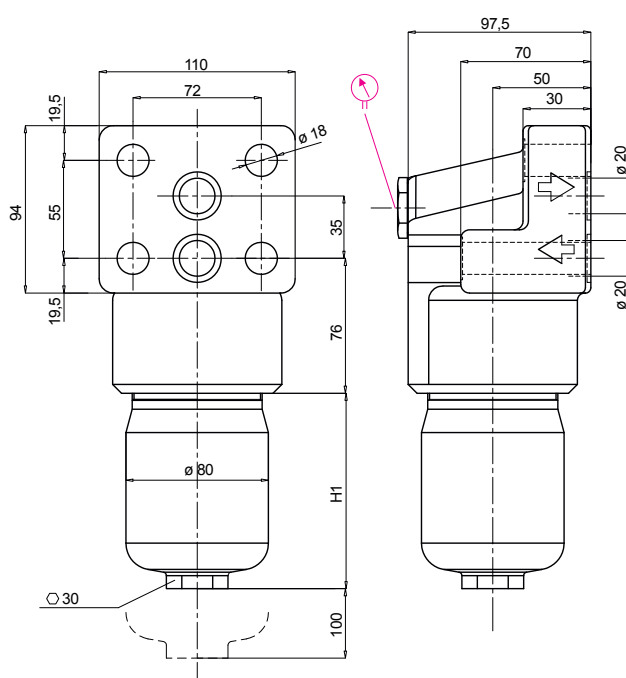
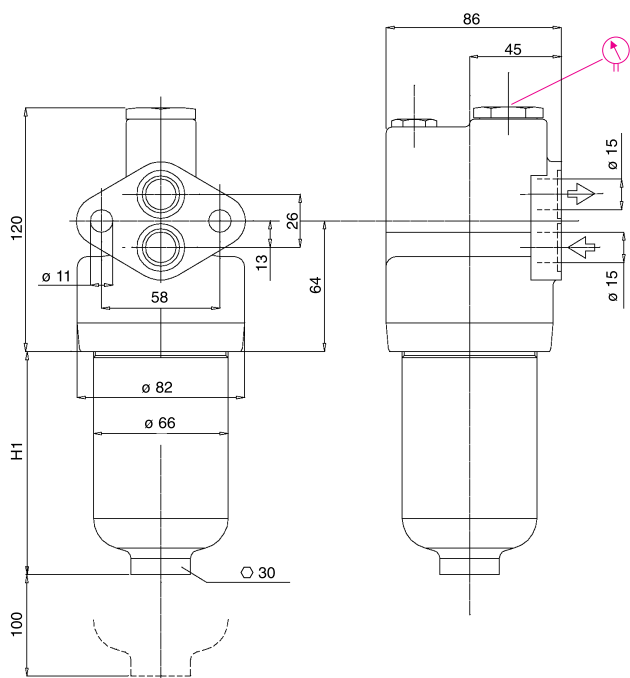

FILTER HOUSING		
	H1	kg
FPL11	79	4,4
FPL12	109	4,6
FPL13	209	5,2
FPL21	116	6,6
FPL22	207	8,2

Pressure Filter - PL

FILTER ELEMENT

	A	B	C	kg media F+&C+	kg media H+	Area (cm ²)		
						Media F+	Media H+	Media C+
EPB11	45	25	85	0,15	0,25	355	340	310
EPB12	45	25	116	0,20	0,55	500	475	435
EPB13	45	25	211	0,30	0,45	935	915	815
EPB21	52	23,5	115	0,25	0,40	975	975	780
EPB22	52	23,5	210	0,35	0,55	1.830	1.785	1.465

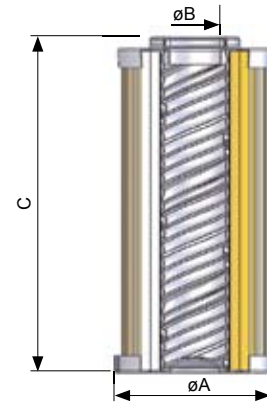

FLUID SPEED

(when selecting the filter size, we suggest to consider also the max recommended fluid speed (in pressure lines normally $5 < v < 10$ m/s))

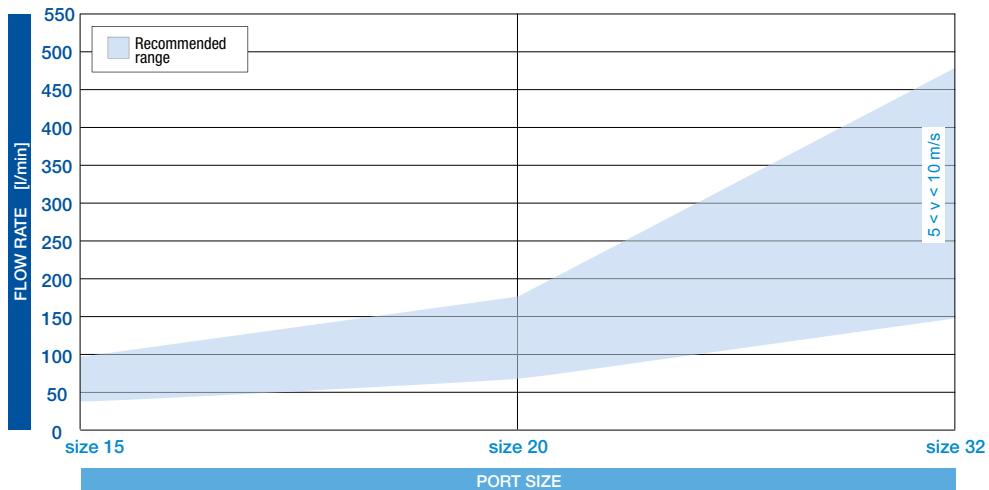

PRESSURE DROP CURVES (Δp)

The "Assembly Pressure Drop (Δp)" is obtained by adding the pressure drop values of the Filter Housing and of the Clean Filter Element corresponding to the considered Flow Rate and it must be lower than 120 kPa (1,2 bar).

FILTER HOUSING PRESSURE DROP

(mainly depending on the port size)

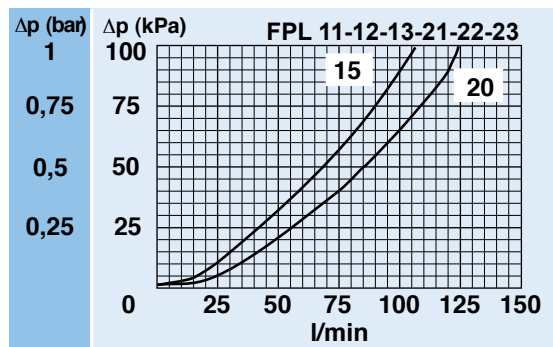

Pressure Filter - PL

CLEAN FILTER ELEMENT PRESSURE DROP WITH F+ AND C+ MEDIA

(depending both on the internal diameter of the element and on the filter media)

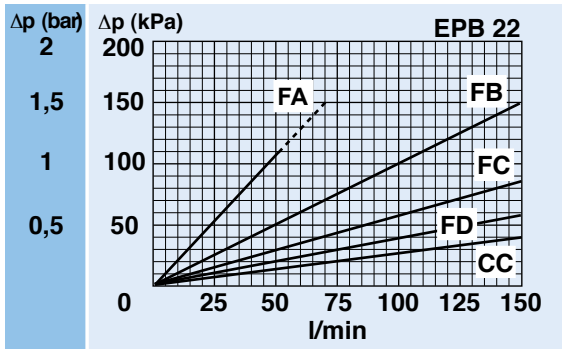
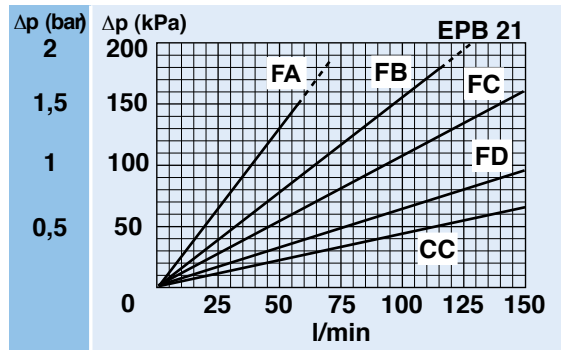
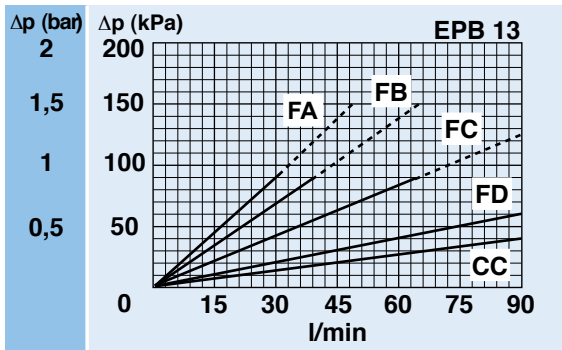
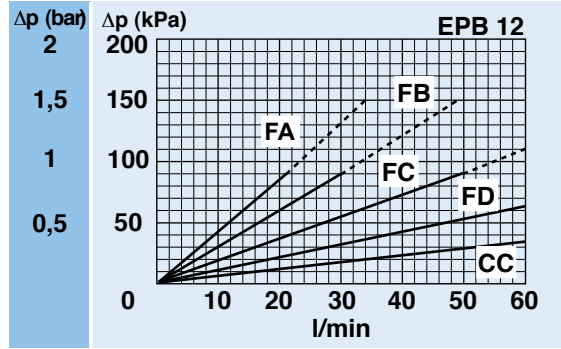
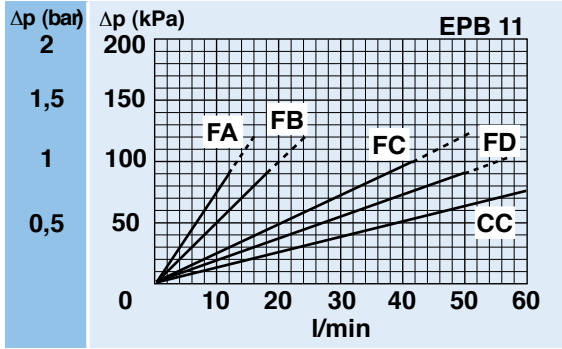

Pressure Filter - PL

PRESSURE DROP CURVES (Δp)

The "Assembly Pressure Drop (Δp)" is obtained by adding the pressure drop values of the Filter Housing and of the Clean Filter Element corresponding to the considered Flow Rate and it must be lower than 120 kPa (1,2 bar).

CLEAN FILTER ELEMENT PRESSURE DROP

(depending both on the internal diameter of the element and on the filter media)

WITH H+ MEDIA

(recommended with no Bypass option)

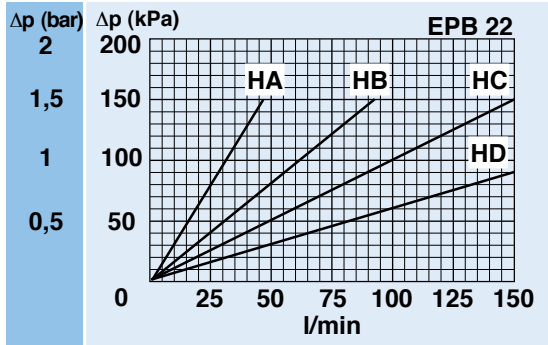
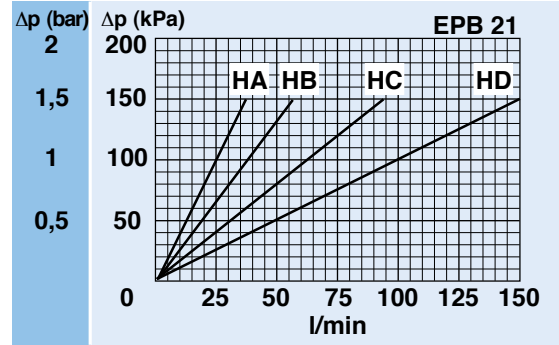
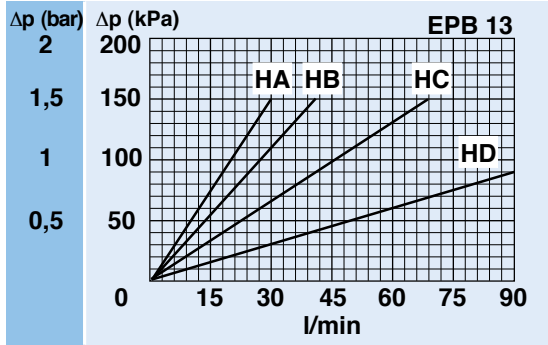
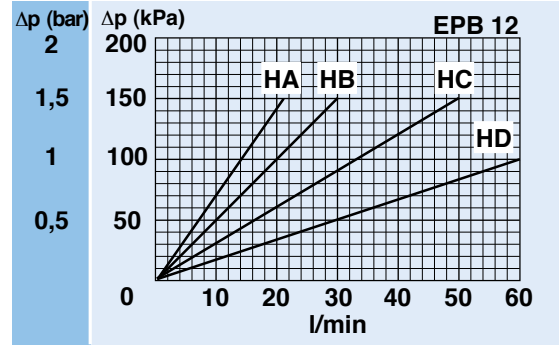
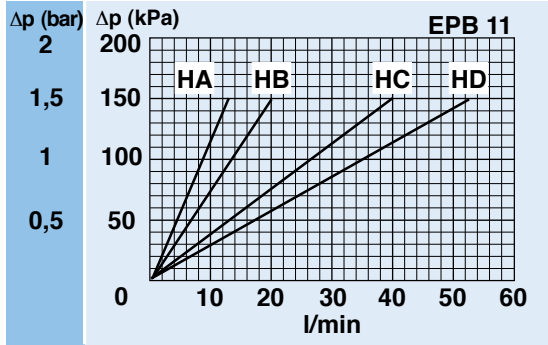

BYPASS VALVE PRESSURE DROP

When selecting the filter size, these curves must be taken into account if it is foreseen that any flow peak is to be absorbed by the bypass valve, it also must be of proper configuration to avoid pressure peaks. The valve pressure drop is directly proportional to fluid specific gravity.

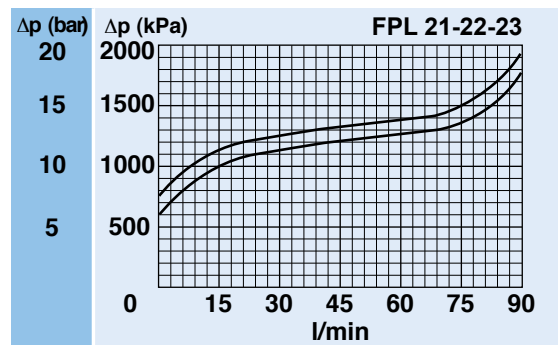
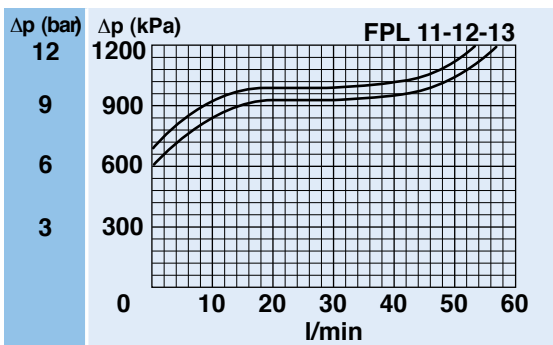

Pressure Filter - PL

CLOGGING INDICATOR

A visual or visual-electrical differential indicator is available as an option and allows monitoring of the element conditions, giving an exact indication of the right time to replace the element.

FILTER HOUSING

The head by high performance cast iron and the bowl by extruded steel ensure the best fatigue resistance to the working pressures.

FILTER ELEMENT

The filter element is manufactured with filter medias selected in the UFI laboratory and mechanically supported to maintain the highest performances even at high differential pressures.

SEAL GUARANTEED

A perfect O-ring seal is always ensured as it is not dependent on the tightening torque applied to the bowl.

EASY ASSEMBLING

The manifold mounting is compact and leak free.

CLOGGING INDICATOR

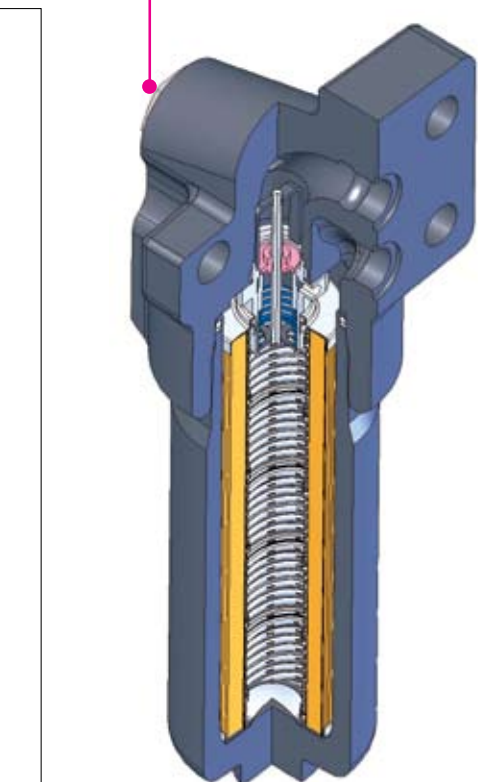

SPARE SEAL KIT

	NBR	FKM
FPL11	521.0080.2	521.0083.2
FPL12	521.0080.2	521.0083.2
FPL13	521.0080.2	521.0083.2
FPL21	521.0081.2	521.0084.2
FPL22	521.0081.2	521.0084.2
FPL31	521.0082.2	521.0085.2
FPL32	521.0082.2	521.0085.2
FPL33	521.0082.2	521.0085.2
FPL34	521.0082.2	521.0085.2
FPL35	521.0082.2	521.0085.2

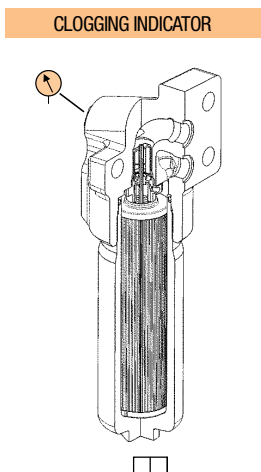
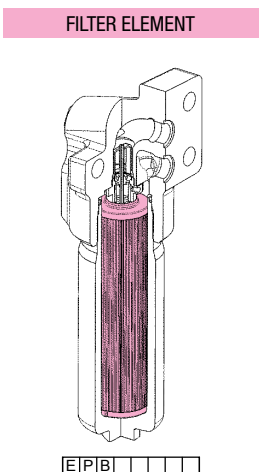
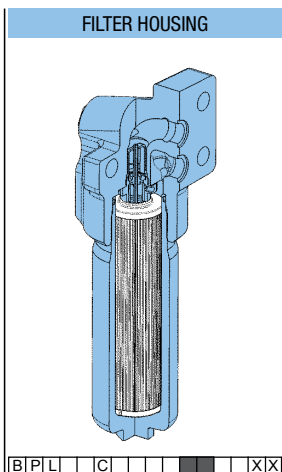

SPARE PARTS ELEMENTS
(For filling up see table "Ordering and option chart")