

PMD – Single Acting Hand Pump with Double Cylinder

Article no.	Max Pressure BAR	Approx Weight Kg	Displacement cm ³	Price £	Price €
PMD5	500	4.2	5	£628.00	€647.60
PMD10	250	4.2	10	£628.00	€647.60
PMD17	150	4.2	17	£628.00	€647.60



Ordering Code

PMD - Y - X

X	Optional	Y	Displacement
		5	5 cm ³
w	Without unloading valve	10	10 cm ³
		17	17 cm ³

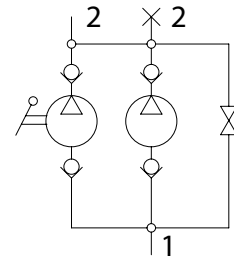

Technical Data

Mineral oil	ISO 6743/4 DIN 51524
Fluid viscosity	10-500 mm ² /s 45 to 2000 ssu (6 to 420 cSt)
Max contamination index with filter	ISO 4406:1999
Fluid temperature	-20°C +80°C
Ambient temperature	-20°C +50°C

It is necessary a filter use to protect the valve (advised filtration 15 micron)

Dimensions (mm)

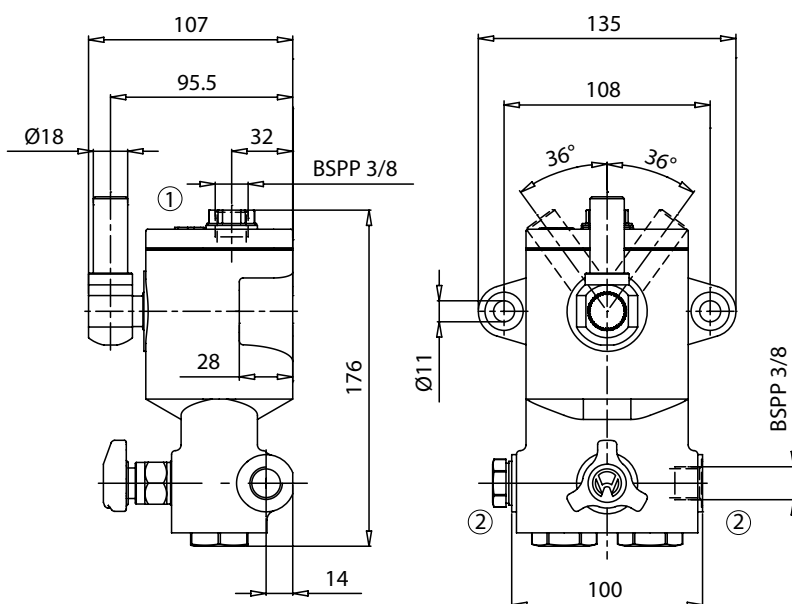

Operating Graph

Effort operating on the end of the lever

